

Mikron

MILL E

500 U
700 U



Becoming better every day – since 1802

GF Machining Solutions

When all you need is everything, it's good to know that there is one company that you can count on to deliver complete solutions and services. From unmatched Electrical Discharge Machining (EDM), Laser texturing, Laser micromachining, Additive Manufacturing and first-class Milling and Spindles to Tooling and Automation, all of our solutions are backed by unrivaled customer service and expert GF Machining Solutions training. Our AgieCharmilles, Microlution, Mikron Mill, Liechti, Step-Tec and System 3R technologies help you raise your game—and our digital business solutions for intelligent manufacturing, offering embedded expertise and optimized production processes across all industries, increase your competitive edge.



+ We are Mikron Mill.
We are GF Machining Solutions.

Contents

4	Market segments and applications
6	Technology and Solutions
8	Robust and precise
10	Benefit from an automated process
12	Automation with pallet magazine
14	Tool magazines
16	High-performance Spindles
17	Spindle challenge
19	Direct torque drive
20	Chip management
22	Our Service + Success range
24	Heidenhain TNC 640 and smart machine
25	Customer Services
26	Options
27	System 3R - JobToolManager
28	Technical data
32	GF Machining Solutions

The Mikron MILL E 500 / 700 U high-efficiency series comprises five-axis machines in a stiff, stable, cast iron C-frame construction. With large-sized guideways and double supported rotary table, this range delivers parts quality and optimum chip removal rate—ideal for job shops and parts producers in automotive, energy and power generation, and general machinery.

Market segments and applications

Typical applications



Aerospace

PART EXAMPLE

Secure process stability – Milling with no chatter marks

Achieve high accuracy and surface quality

Get ready for production ramp-up with no worries

Plate cover
Material: AL 7575



Wall thickness
0.5mm

Surface finish
Ra 0.5µm

Accuracy
± 0.05mm

Repeat-ability
24 / 7
parts production

Process



Medical

PART EXAMPLE

Get a turnkey solution

Reduce cost of operations

Achieve high surface quality

Surgical support device
Material: AL 6061



Surface finish
0.3µm

Process time
6.5h

Production cost reduced by
30%

Unique



Medical

PART EXAMPLE

Speed-up operations and reduce cost: one clamping

Efficient process – from roughing to finishing

Productive and flexible serial production

Swivel range of
+120° to -65°

Surface finish
Ra 0.5µm

Processing time
80min



Process

Hook bone plate
Material: SS 17-4



Automotive

PART EXAMPLE

Lever flexibility:
many different milling
processes

Reduce cost:
Mill efficiently with
5-Axis

Secure process
stability over long
milling periods

Tools from
Ø4mm to
Ø40mm

Process
time
23h

Accuracy
±
0.03mm

Removed
material
0.021m³
/min

Airbag shooting device
Material: AL 6082

Process

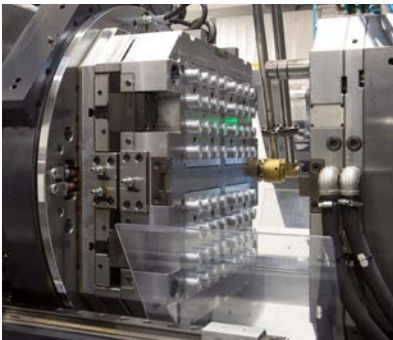

Mold and die

PART EXAMPLE

Deep cavity Milling

High surface finish

Continuous cutting
speed thanks 5-Ax
simultaneous Milling

Cookie blister
Material: AL 6082

Accuracy
±
0.05mm

Removed
rate
+210cm³
/min

Tool
diameter
1.5mm

Surface
finish
Ra
0.5µm

Process



Machinery and general mechanics

PART EXAMPLE

Achieve high positioning
accuracy in 5-Axes

High material removal
rate

Variable operations
on all five sides

Multiple machining
operation

Deformation-free
machining

Cover plate
Material: AL 6082

Wall
thickness
< 1mm

Removed
rate
+210cm³
/min

Accuracy
±
0.05mm

Process



Technology

High-efficiency Milling

The Mikron MILL E U series is a dynamic, high-efficiency machine center for entry-level five-axis machining.

It provides highly efficient and productive processing for all kinds of materials, including aluminum alloys and stainless steel. This solution's economical design saves spaces and its ergonomics make it easy for your operator to use.

- + Produce your workpieces in a process-secure and precise manner.
- + Increase reliability in unmanned operation.
- + Boost the service life of the machine.
- + Significantly reduce production costs.

**Efficiency
and productivity
for 5-Axis
machining**



Solutions

The right solution—for you

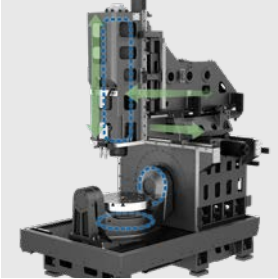

Stiff machine construction

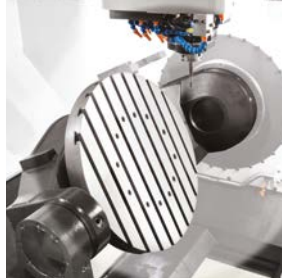

Double-supported rotary torque table



Step-Tec Spindle:
120 Nm, 20,000 rpm



Choice of HEIDENHAIN
or FANUC control

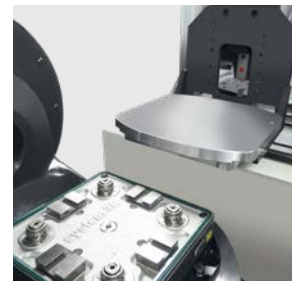

Integrated Automation or
third-party automation

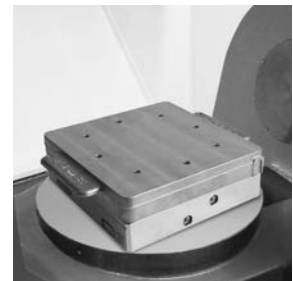

Integrated palletization

Customer benefits

- + Benefit from the dynamic behavior essential to perfect part production.
- + Machine under maximum load generates minimal noise and achieves top quality on your parts.
- + Get the performance and Spindle power to execute all kinds of applications.
- + Enjoy unmanned production—nights or weekends—with your favorite Automation system.

Robust and precise

MILL E 500 U / 700 U core components

+ Up to 60 tools integrated. 215 tools on a tool tower

Easy loading during operation

+ Torque or gear drives for rotary table

High positioning accuracy and repeatability thanks to direct drive technology

+ Large swivel range from -65° to $+120^{\circ}$

Allows perfect access with the optimal tool length to the part

+ 20,000 rpm motor spindle with 120 Nm

Best surface finish for both roughing and finishing

+ Compact footprint and ergonomic access

Highest efficiency and ergonomics on smallest space

**More than 50 years legacy of
machine design expertise**



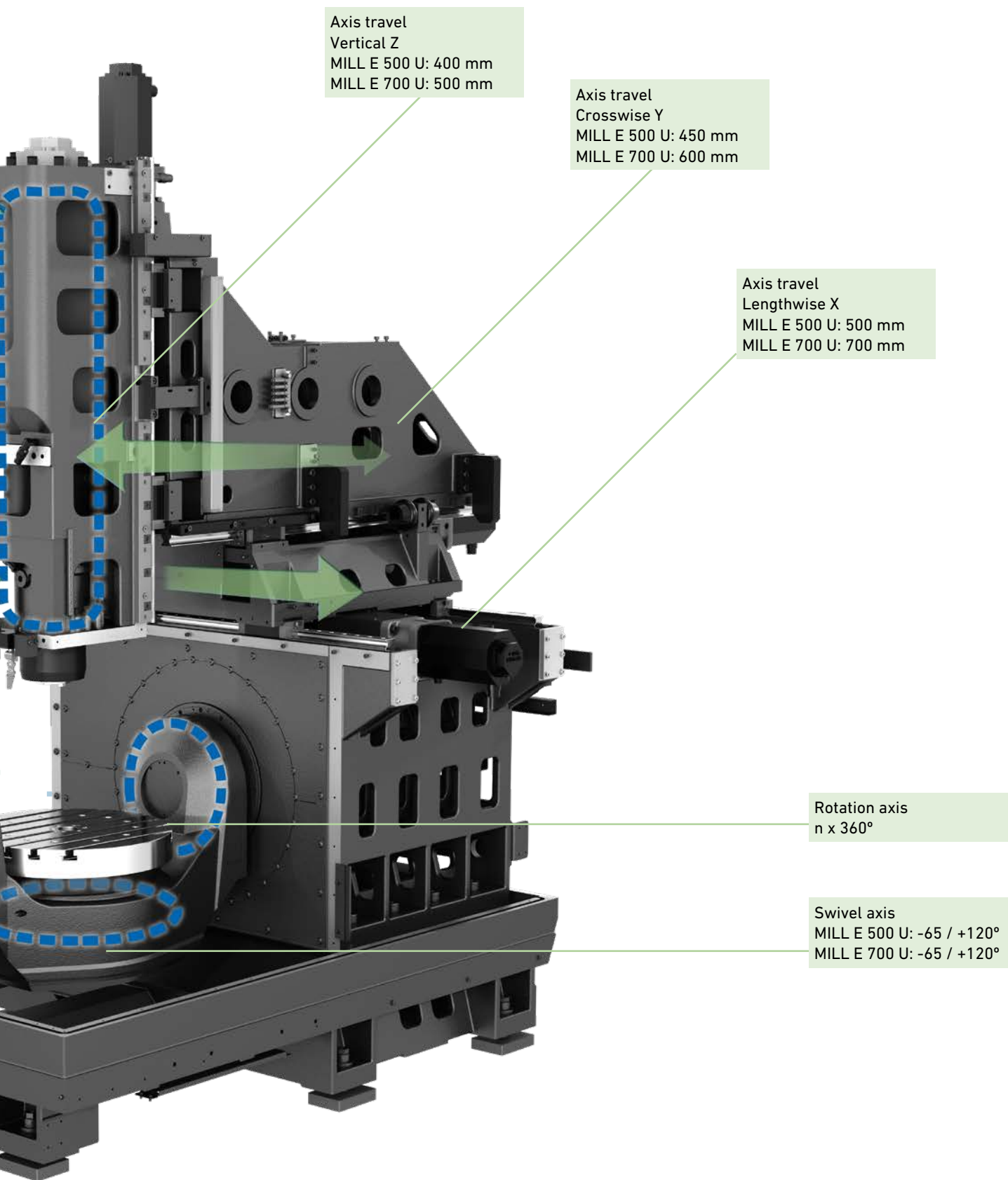

Axis travel
Vertical Z
MILL E 500 U: 400 mm
MILL E 700 U: 500 mm

Axis travel
Crosswise Y
MILL E 500 U: 450 mm
MILL E 700 U: 600 mm

Axis travel
Lengthwise X
MILL E 500 U: 500 mm
MILL E 700 U: 700 mm

Rotation axis
n x 360°

Swivel axis
MILL E 500 U: -65 / +120°
MILL E 700 U: -65 / +120°

Benefit from an automated process

Ramp up your productivity and flexibility

Execute small, express jobs with the same efficiency and profitability as mid-size series or repeat orders.

Your progress to higher productivity:

Step 1

Move from three-axis, multi-clamping Milling to five-axis, one-clamping Milling.

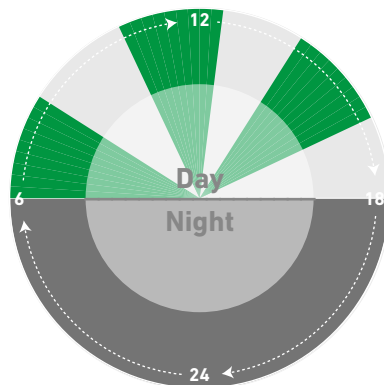

+46%
productivity

Step 2

Upgrade the machine: clamping with System 3R

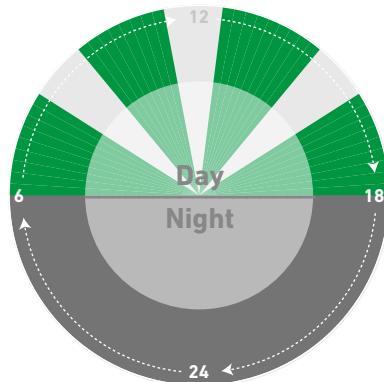

+20%
productivity

Step 3

Extend your system: pallet magazine and clamping with System 3R

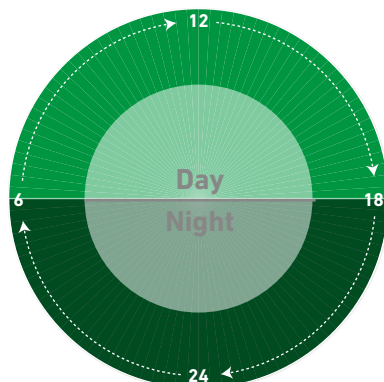

+16h
additional capacity
daily

You'll run additional
shifts 24/7 at lowest
cost.

- + Fast setup time
- + Lowest machine downtime
- + High profitability
- + Broad flexibility
- + Efficient productivity



Generate a fast return on invest with a Mikron MILL E 500 U with 20,000 rpm Spindle, simultaneous torque table and our own pallet Mikron Mill pallet Automation with up to seven pallets.

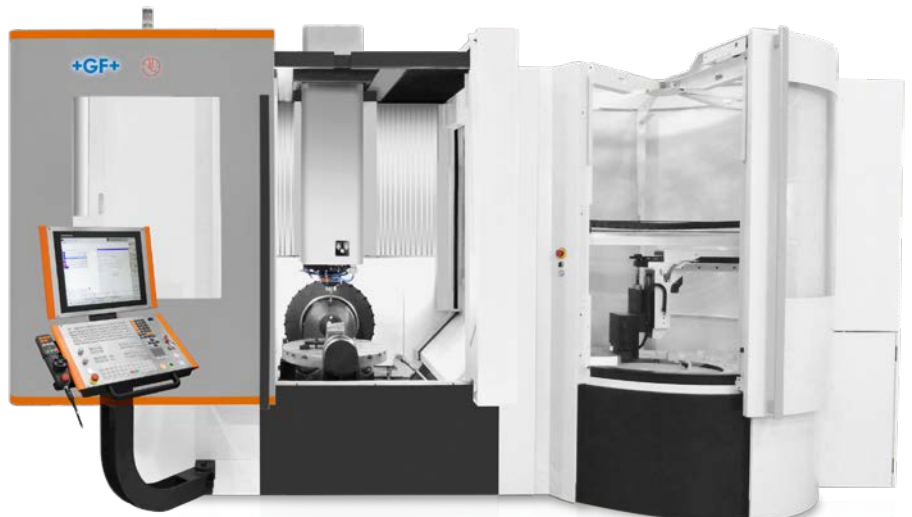

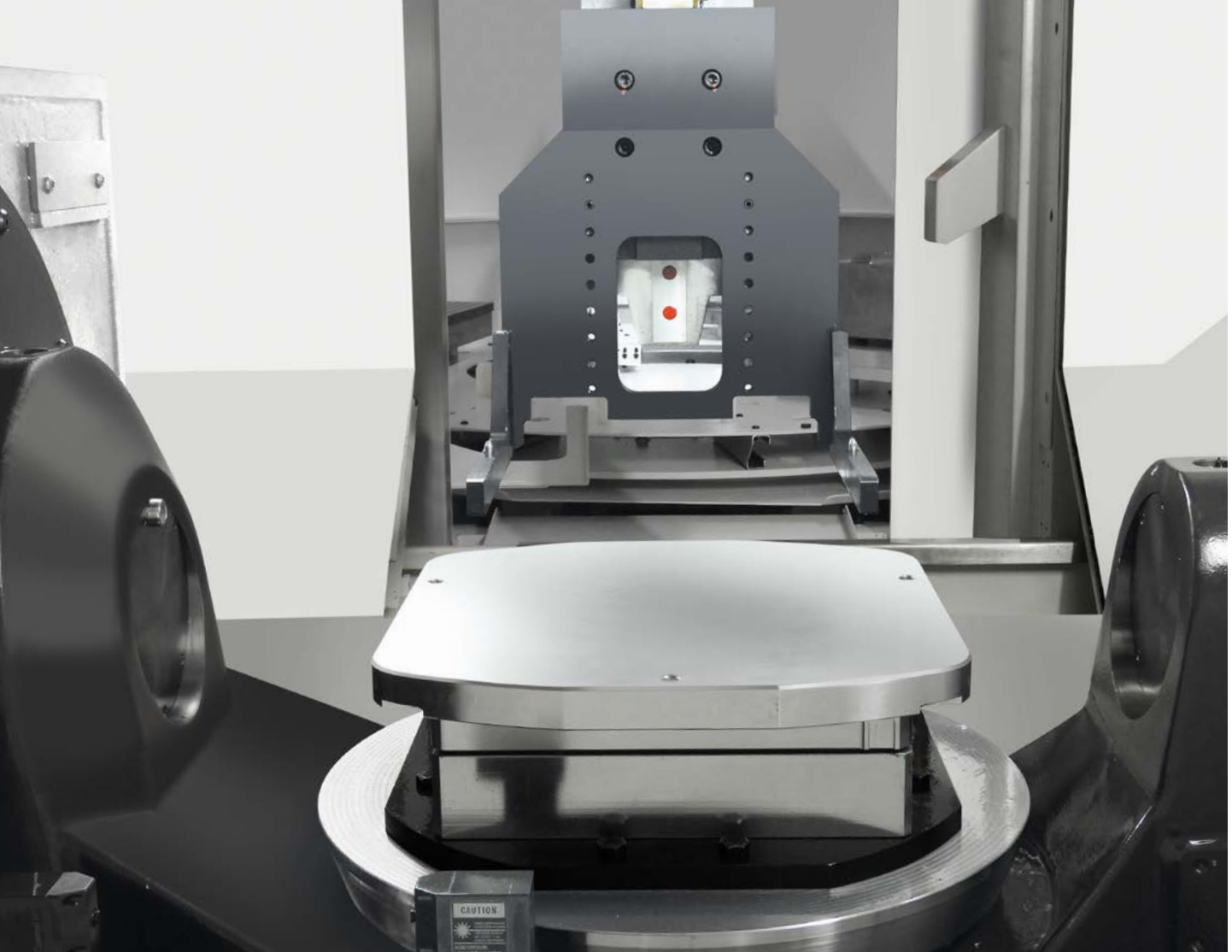

Automation with pallet magazine

Integrated palletization

Take your productivity to new levels while reducing your costs with our superior Automation solution. The pallet magazine's generously dimensioned door allows optimum pallet access for loading light parts by hand and heavy parts by crane. Larger windows allow a good view into the pallet area, and pallets are managed by using the machine control.



Ergonomic door design for easy loading of parts up to 200 kg

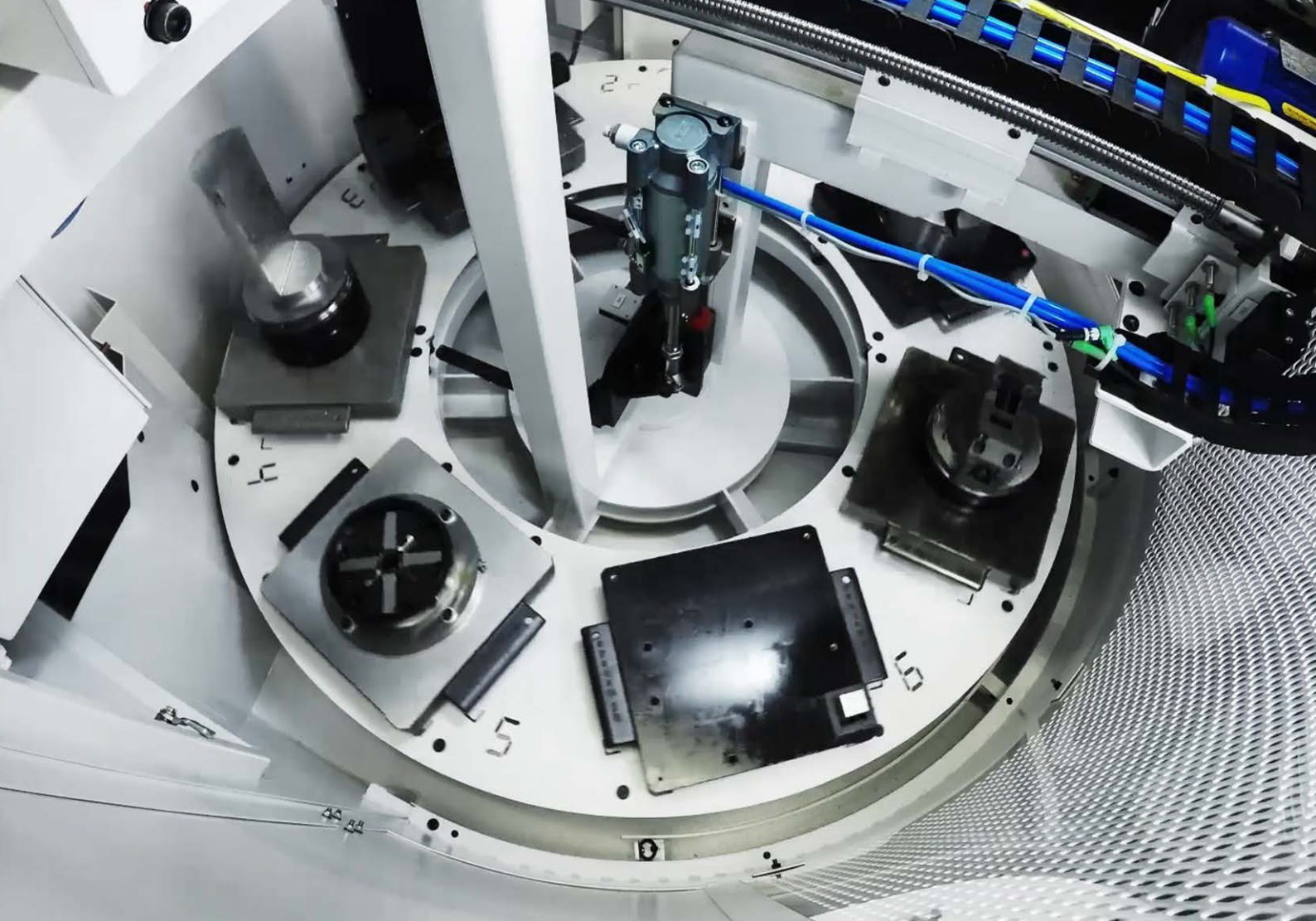

Five-sided processing in one clamping

5-Axis processing offers significant advantages for large and small components. Using 5-Axis technology, it is possible to process different shapes and surfaces with one clamping device.

- + Rotary swiveling table available as a pallet version: System 3R (Dynafix/Delphin)
- + Rotary swiveling table available as a generously dimensioned tabletop version (Ø 500 / 630 mm with parallel T-grooves)
- + Cartesian (right-angled) arrangement of the axes results in easily understood tool/workpiece movements during the Milling process
- + Direct measurement on the B and C axes
- + Machine available as 5-Ax or 5-Axis simultaneous versions

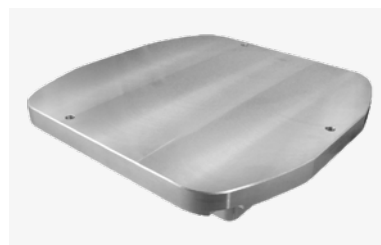

Dynafix pallet Automation

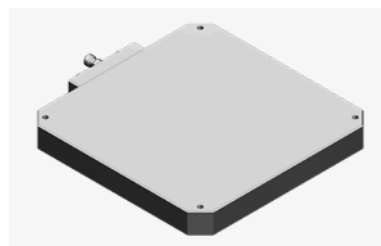

Delphin pallet Automation

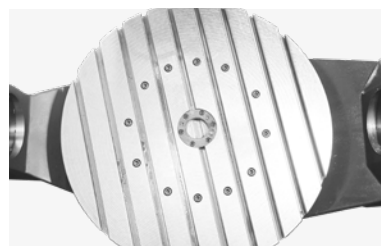

Rotary swiveling table with parallel grooves

Tool magazines

We have the solution for your needs

- + Ergonomic and user friendly
- + Ensures productivity and process reliability
- + Parallel machining and tool loading
- + Easy tool loading possibilities thanks to an ergonomic tool loading door

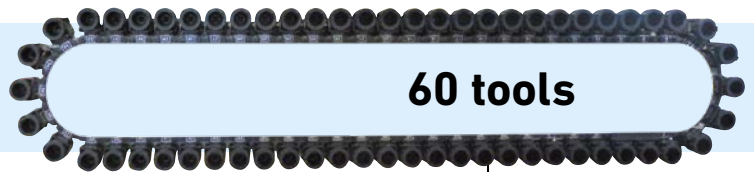

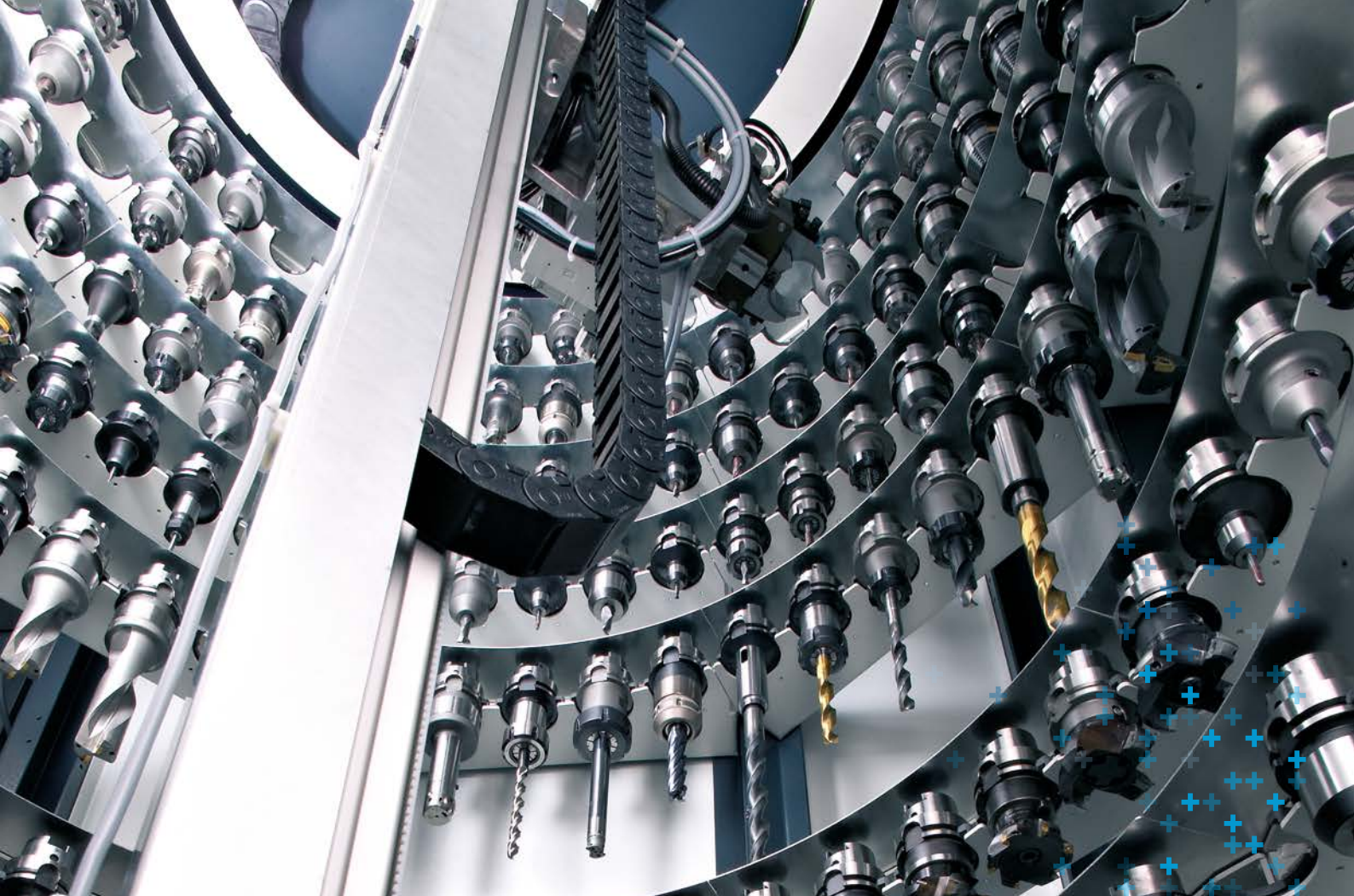

120, 170 or 215 tools

Circular magazine design with handling system

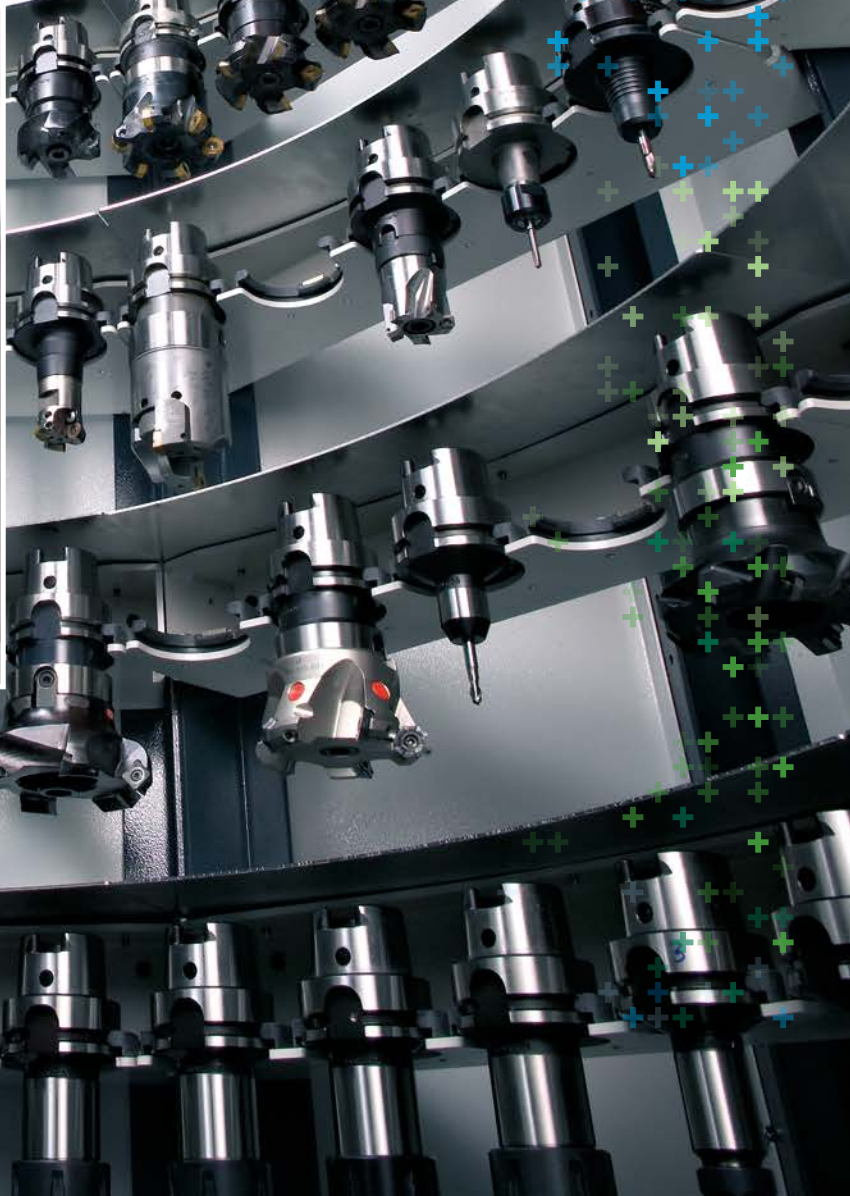

High-performance Spindles

High-efficiency Milling and effective processing

The high-performance Spindles on the Mikron MILL E 500 U / 700 U series are designed to do heavy roughing and Milling to best surface finish all at once. With a bearing design with three preloaded hybrid ball bearings in the front and a thermally robust hybrid cylindrical roller bearing on the back, you are guaranteed a super-rigid rotating system that enables Milling with extra-long tools reaching into deep cavities. Ramp up your chip removal, thanks the feed rates made possible by this solution's absorption of high Milling forces at the tool tip.

The 20,000 min⁻¹ Spindle features the well-proven OptiCool principle that keeps the front bearing area cool while the extra heat barrier cooling loop keeps the motor heat away from the Spindle nose. That results in a thermally balanced Spindle thus assuring a high level of precision, repeatability and surface finish.

Spindle 20,000 min⁻¹

Power (S6)	36 kW
Torque (S6)	120 Nm
Speed max.	20,000 min ⁻¹
Acceleration	2.5 s
Lubrication	Oil-air
Tool interface	HSK-A63 DIN69063-1

- Direct Lubricating System (DLS) oil-air bearing lubrication through outer race
- Fully digital Spindle equipped with every conceivable sensor to support smart machine integration
- Through-Spindle cooling featuring rotary unions fed by all known liquid and gaseous media



The 12,000 min⁻¹ Spindle delivers sufficient performance and power for all kinds of applications. The ball bearings, which are lubricated for life, are effectively protected against incoming dirt with an air purge system. The tool is held by a spring and is released through hydraulic cylinder.

Spindle 12,000 min⁻¹

Power (S6)	20 kW
Torque (S6)	88 Nm
Speed max.	12,000 min ⁻¹
Acceleration	2.5 s
Lubrication	Oil-air
Tool interface	ISO 40 / BT 40 / CAT 40

- Good thermal stability through OCS
- Excellent weight/performance ratio
- Integrated intelliSTEP functionality
- Spindle cone ISO 40/BT 40/CAT 40
- Infinitely variable rotation speed range—no loss of performance
- Prepared with internal cooling agent feed for production use (optional)



Spindle challenge

Slotting operation

Description

- Slotting with a depth of 1.5xD is a challenging task for the machine.
- The feed rate was set to a spindle load of 85%.
- Tests with more speed brought the machine to soar up.

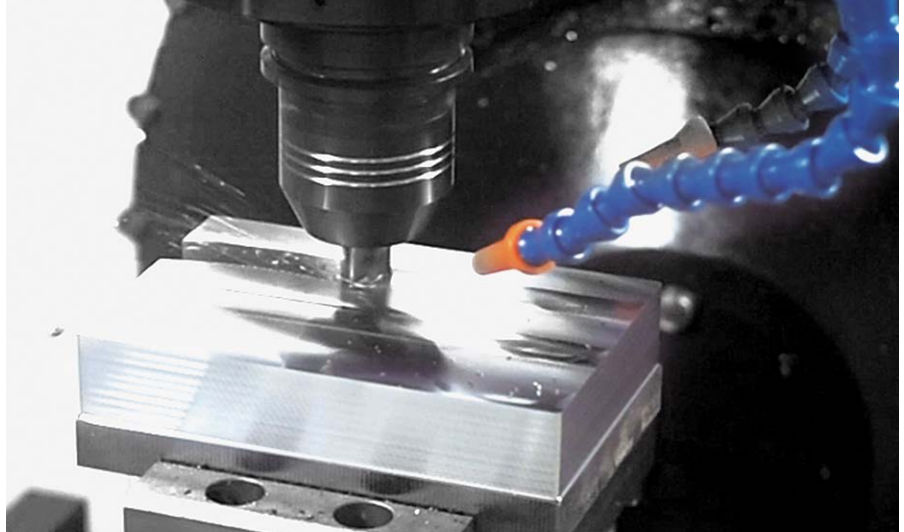

Tool

- Type: Ø 16 mm end mill
- Manufacturer: FRANKEN (2615AZ.016)

Processing parameters

- Spindle speed: 2,586 min⁻¹
- Feed rate: 1,034 mm/min
- Cutting depth: 24 mm
- Step over: 16 mm
- Material removal rate: 397 cm³/min

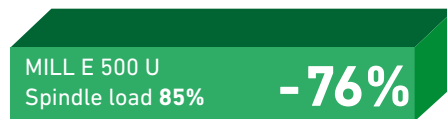

Machinery and general mechanics

PART EXAMPLE

- Faster processing
- Higher chip removal rate
- Less vibration and longer machine live time

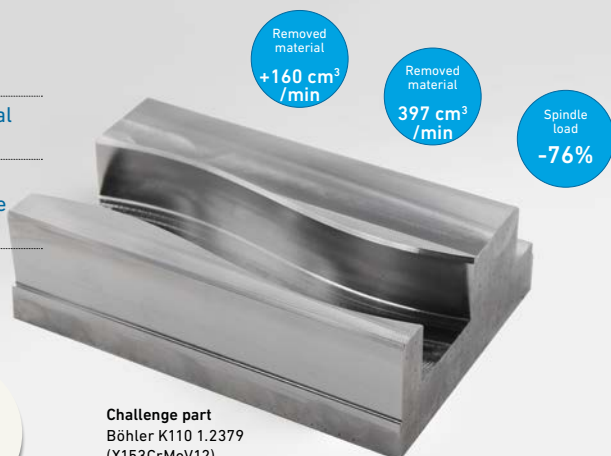

Process

- + No wear
- + High dynamics
- + High accuracy
- + No backlash

The standard version of the swivelling table is ideally suited to the machining of workpieces in multiple clamping devices.

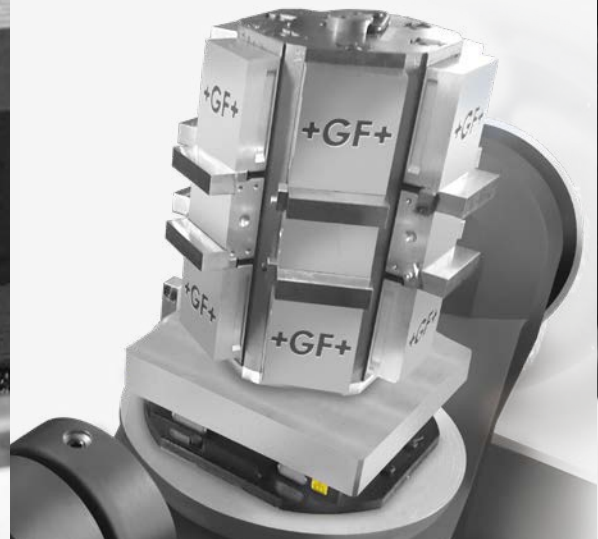

Direct torque drive

Direct drive rotary tilting table

Direct torque drive technology allows excellent precision and surface finish on the workpiece. The fact that there are no mechanical transmission elements involved in the force transmission means that friction and wear as well as reduction in dynamic and rigidity are things of the past. All rotary tables are designed and manufactured in-house by GF Machining Solutions.

Experience high dynamics due to no mechanical transmission elements.

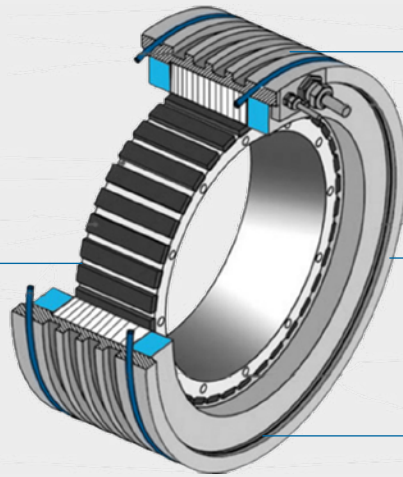

Water cooling ensures optimum heat transfer.

Fixation damping absorbs stress and vibration.

Contactless motor system eliminates wear and ensures a long lifetime.



Automotive

PART EXAMPLE

Ensure positioning accuracy on five-sided parts.

Secure repeatability over series production.

Get ready to rapidly achieve stable quality.

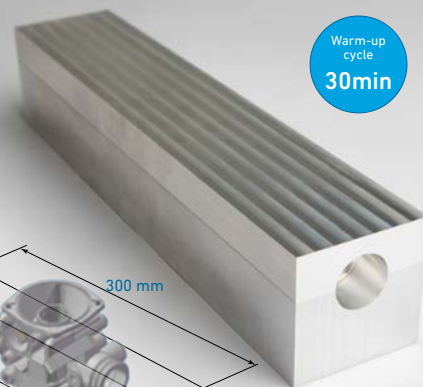

Warm-up cycle
30min

Thermal stability
24/7

Repeatability within
10µm

Concentricity of two holes
<10µm

Bore length
2x 150mm

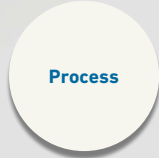

Concentricity challenge

Chip management

Clean machining, wet or dry

Adapted chip management

- **Solution for high-volume small and light chips** with lift-up scraper chip conveyor and coolant unit with fine filtration
- **Solution for high-volume steel Milling chips** with lift-up scraper chip conveyor and coolant filtration unit

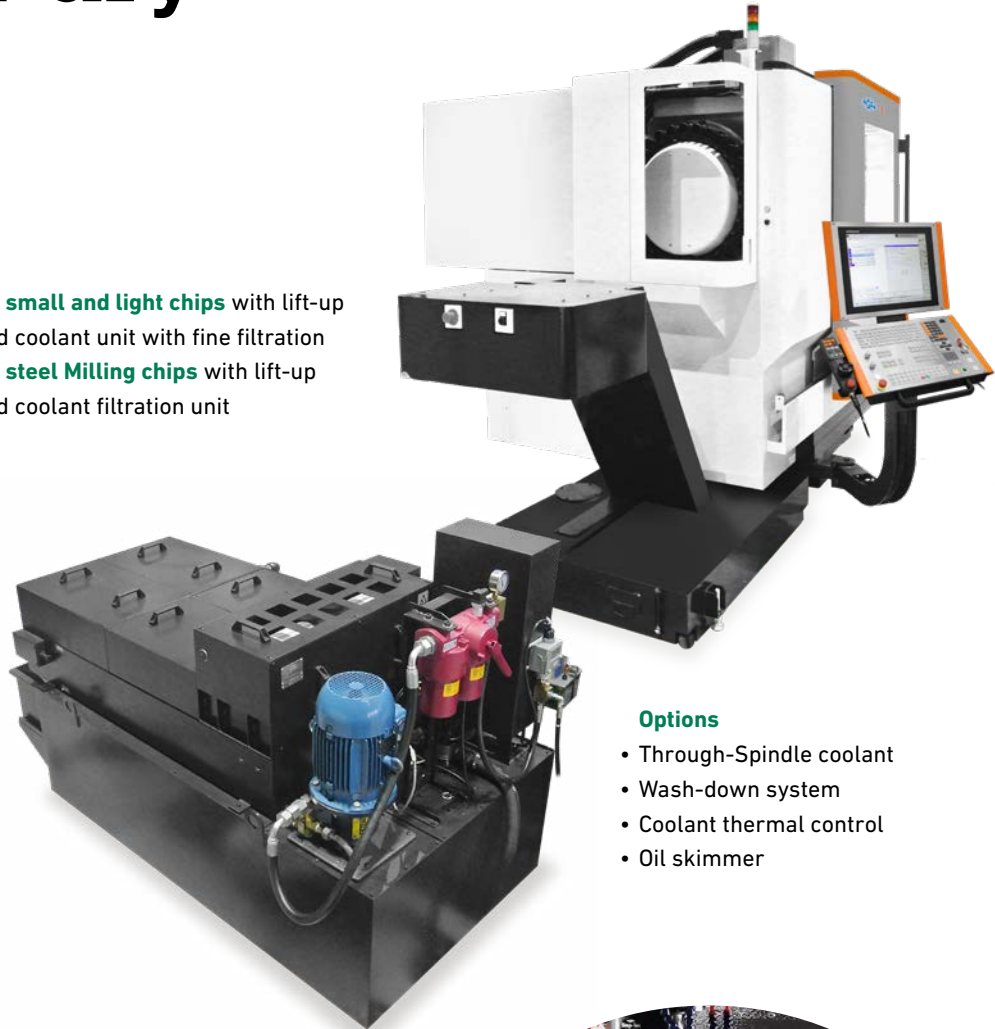

Options

- Through-Spindle coolant
- Wash-down system
- Coolant thermal control
- Oil skimmer

- + Optimum chip flow to steep and smooth cabin walls
- + Wash-down nozzles for all corners to prevent chip accumulation
- + Professional lift-up scraper to transport 43 l/h chips out of the working area



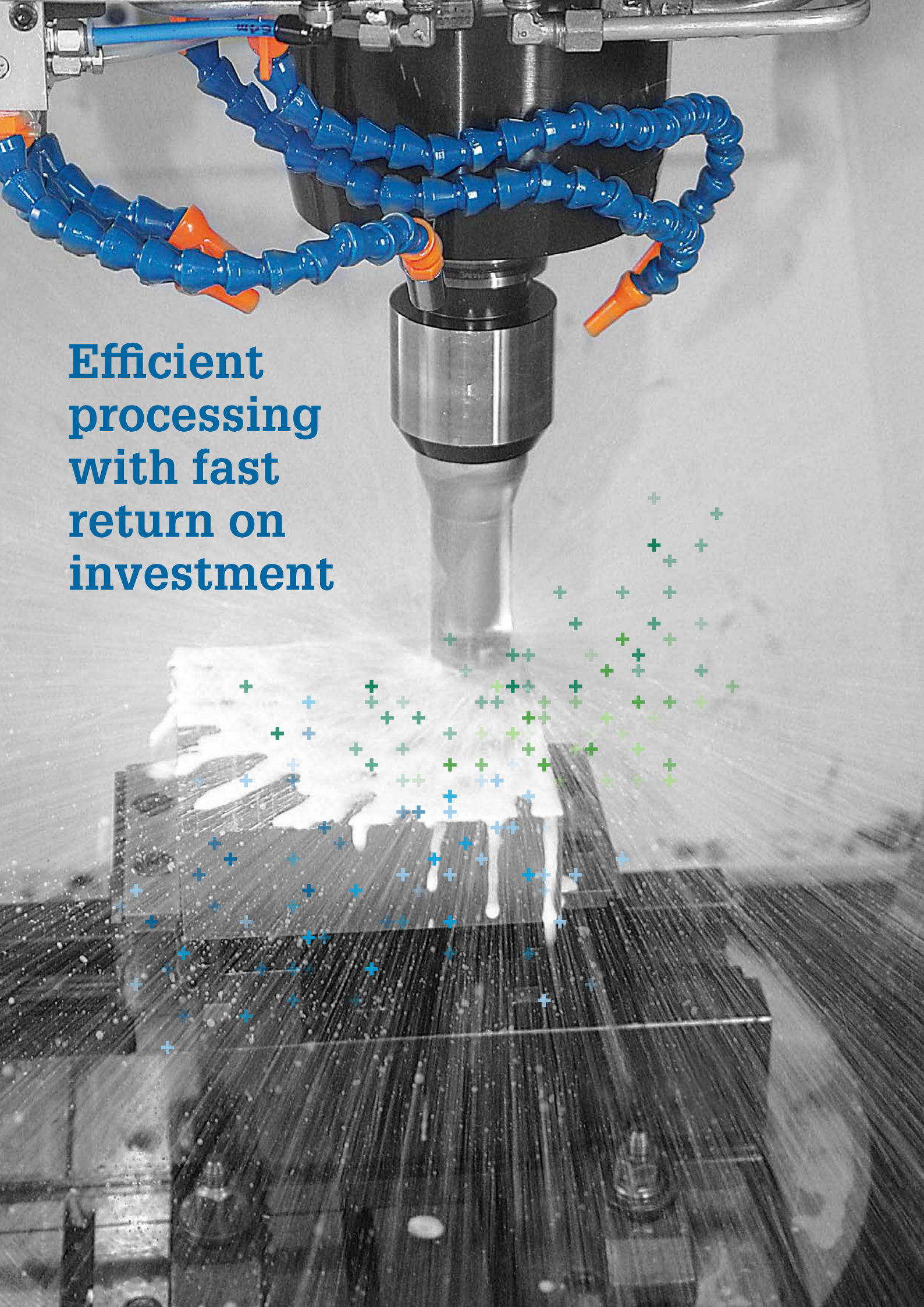

**Efficient
processing
with fast
return on
investment**



Our Service + Success range

We take you to new heights

Guiding your ascent

Whether it is Milling, EDM, Laser Texturing or Additive Manufacturing, our Service + Success experts guide you throughout the entire lifecycle of our Machining and Automation tools in order to help you reach your peak performance. Our trusted experts backed by our latest cutting-edge, intelligent Digital Solutions, provide a **full range of services**.



Operational steering
Hands-on and operational service interventions with supply of consumables and wear parts



Advanced diagnosis
Machine check-up, preventive maintenance and advanced services including original spare parts availability in all our hubs around the world



Certification
State-of-the-art reference by industry sector and on machining equipment



Upgrades
Designed to add value to the original machine investment in order to achieve higher sustainable productivity



Training
Performance oriented academy with a human-centric approach of knowledge transfer in order to realize the full potential of our solutions



Transformation
Strategic partnership from made-to-measure advice on business model evolution to industrial implementation



Financial solutions
For the optimization of operating costs featuring minimal initial expenditure programs and leasing options

Our Success Packs

As a long-time partner, since 1802 we have been serving various industrial segments and have been dedicated to providing you with a first-in-class combination of services.

We have conceived our new Success Packs range for maximizing **your return on investment**, empowering you in your quest for success whatever your industrial profile.



Silver +
Secure
your future



Silver
Set the foundation
for growth



Bronze +
Achieve flawless
production



Bronze
Get back on
track fast



Optimal machining to enhance your process beyond program and machine setup

This includes a range of modules collectively referred to under the generic term “smart machine” and that fulfill various functions. In order to make the Milling process “intelligent,” various requirements have to be implemented.

- 1 is establishing comprehensive communication between man and machine, which makes available precise information that the operator requires to assess the Milling process.
- 2 is supporting the operator in the optimization of the process, which considerably improves the performance.
- 3 is the machine optimizing the Milling process, which improves process safety and workpiece quality—especially important in unmanned operation.



- + Produce your workpieces in a process-secure and precise manner.
- + Increase reliability in unmanned operation.
- + Boost the service life of the machine.
- + Significantly reduce production costs.

The Heidenhain TNC 640 control provides flexibility and efficiency from job preparation until part is milled. Mounted on a pivot arm to give more operator's accessibility, the touchable screen allows the operator to quickly navigate through the control. Thanks to a user-friendly and practical interface in combination with several functionalities, the TNC 640 support operators in their daily job giving to them more availability for other tasks.

Saving energy

smart machine modules like Econowatt, saving up to 50% energy, are ecological necessities with attractive economic advantages.

Saving energy



Precision



Precision

smart machine modules like ITC and Kinematic opt support the precise base of your machining center to achieve an even more precise final part.

Protection



Protection

smart machine modules like PFP protect and extend the lifetime of your machine and tools.

Customer Services

New digital service possibilities

GF Machining Solutions Customer Services continues to push technological boundaries to deliver the future of services to you—today.



rConnect provides a digital services platform for all GF Machining Solutions technologies. This modular system includes a range of services – all backed by TÜViT-certified cybersecurity – to increase your manufacturing productivity.

rConnect Messenger lets you track production status with machine data updates on your mobile device. Monitor your entire shop and maximize your productivity from anywhere in the world, right on your smartphone.

rConnect Live Remote Assistance (LRA) enables our expert engineers to help you maximize machine uptime with quick responses to your service requests through audio, video chat and more.



Options

Multiple options to drive your success

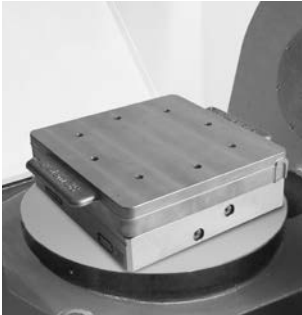

Pallets



Laser tool measuring system



Infrared measuring probe



Mist extraction



Air through Spindle/
coolant through Spindle



Wash down system



TSC belt filter system (20 bar)



Rotating inspection window



Operation mode 3

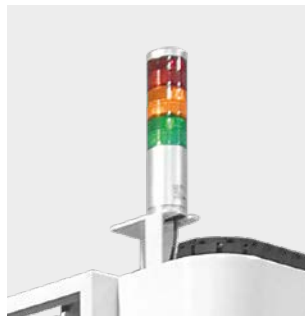

Signal light

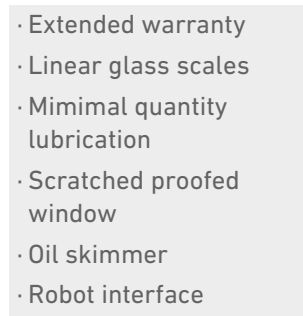

- Extended warranty
- Linear glass scales
- Minimal quantity lubrication
- Scratched proofed window
- Oil skimmer
- Robot interface

Additional options

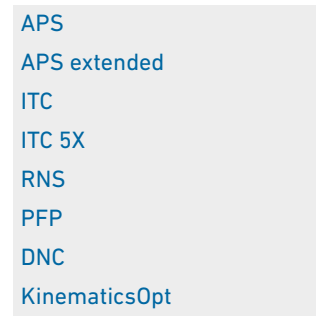

- APS
- APS extended
- ITC
- ITC 5X
- RNS
- PFP
- DNC
- KinematicsOpt

smart machine



Fanuc control system

Reliable and cost-performance CNC with high-end features like NANO interpolation and AI contour control

Performance and reliability

The Fanuc 0i-MD features an ultra-compact design using limited cabling to ensure highest reliability and provide easy maintenance.

Coupled with the latest Fanuc drive technology, the Fanuc 0i-MD ensures smooth machined surfaces by using a much finer resolution for position commands.

System 3R - Pallet and tool management software

JobToolManager (JTM)

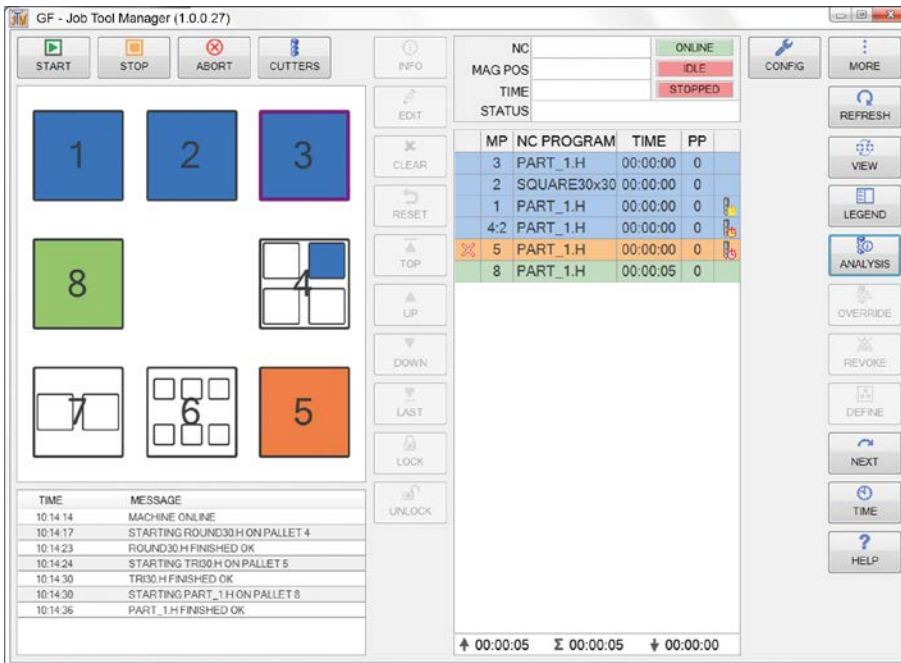

User friendly software for one machine with integrated pallet changer.

Assign NC programs to pallet position by drag and drop on a touch screen, close to the pallet changer.

Advantages

- + Easy to change priorities when the machine is working
- + Add or remove jobs while machining
- + Jobs where cutters are missing will not be started
- + Estimated and present machining time for the magazine content are calculated.

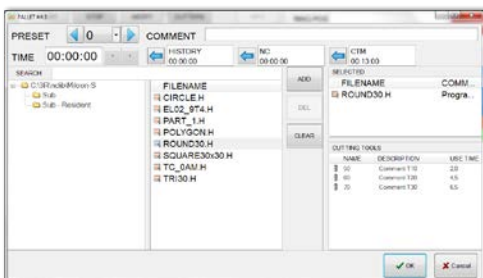

Assign NC file, check tool capacity, schedule

By selecting the NC program, JobToolManager registers the tools used in the program. Time is stored if the NC program defines the time for the entire machining or if each tool has its use time.

If the program has been used earlier, it automatically displays the last recorded time.

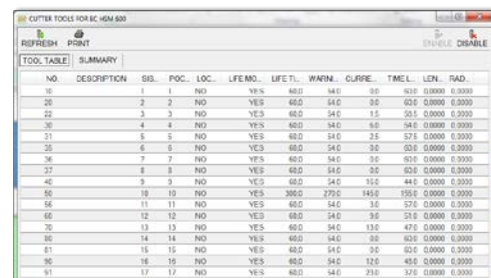

Manage tools upon jobs to be done

Each time a new job is started, JobToolManager checks the machine tool table to see the availability of tools. If a tool is broken and no sister tool is available, the job will be blocked.

Technical data



MILL E 500 U



MILL E 700 U

			MILL E 500 U RTT 5-Axis	MILL E 500 U RTT 5-Axis simultaneous	MILL E 700 U RTT 5-Axis	MILL E 700 U RTT 5-Axis simultaneous		
Axis travel								
Lengthwise	X	mm	500	500	700	700		
Crosswise	Y	mm	450	450	600	600		
Vertical	Z	mm	400	400	500	500		
Swivel axis		°	-65 / +120	-65 / +120	-65 / +120	-65 / +120		
Rotation axis		°	n x 360	n x 360	n x 360	n x 360		
Axes			3+2	5-Axis simultaneous	3+2	5-Axis simultaneous		
Spindle								
Spindle type			In-line	Motor	In-line	Motor	In-line	Motor
Max. rotations	min ⁻¹		12,000	20,000	12,000	20,000	12,000	20,000
Max. torque	kW/Nm		20/88	36/120	20/88	36/120	20/88	36/120
Tool interface			ISO 40 BT 40 CAT 40	HSK-A63	ISO 40 BT 40 CAT 40	HSK-A63	ISO 40 BT 40 CAT 40	HSK-A63
Travel speed								
Rapid traverse	X, Y, Z	m/min	30 / 30 / 30	30 / 30 / 30	30 / 30 / 30	30 / 30 / 30		
Rapid traverse	B, C	min ⁻¹	17 / 28	32 / 112	17 / 28	32 / 112		
Automation								
Integrated tool magazine	unit		DT 30 / CT 60	DT 30 / CT 60	DT 30 / CT 60	DT 30 / CT 60		
Tool tower	unit		120 / 170 / 215	120 / 170 / 215	120 / 170 / 215	120 / 170 / 215		
Pallet magazine	unit		5 Delphin 400/400 or 5 MTS 400/400 or 7 Dynafix 350/350 or 7 UPC 320/320	5 Delphin 400/400 or 5 MTS 400/400 or 7 Dynafix 350/350 or 7 UPC 320/320	5 Delphin 400/400 or 5 MTS 400/400 or 7 Dynafix 350/350 or 7 UPC 320/320	5 Delphin 400/400 or 5 MTS 400/400 or 7 Dynafix 350/350 or 7 UPC 320/320		
Pallet changing time	sec.		30	30	30	30		
Robot interface			Available	Available	Available	Available		
Rotary swivel table								
T-groove table	mm		500	500	630	630		
Workpiece weight (3/5)	kg		300	300 / 200	450	450 / 450		
Weight								
Machine weight	kg		6,030	6,030	8,060	8,060		
Control								
Heidenhain			TNC 640	TNC 640	TNC 640	TNC 640		
Fanuc (12,000 min ⁻¹)			0i-MD	-	0i-MD	-		

MILL E 500 U

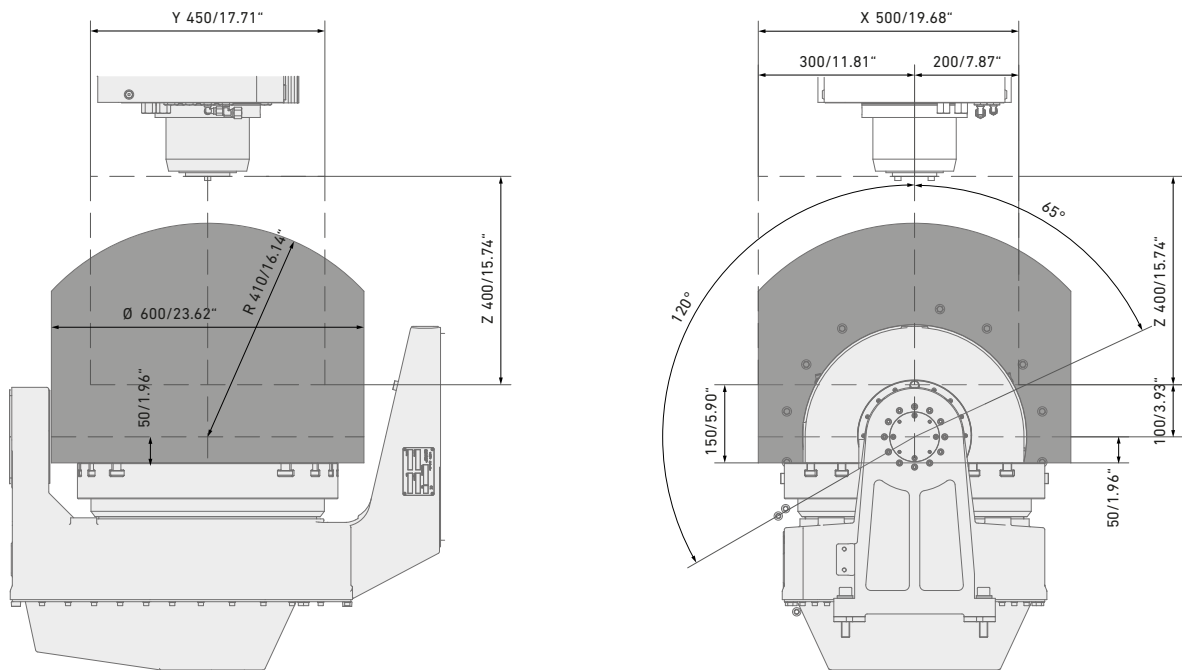

MILL E 700 U

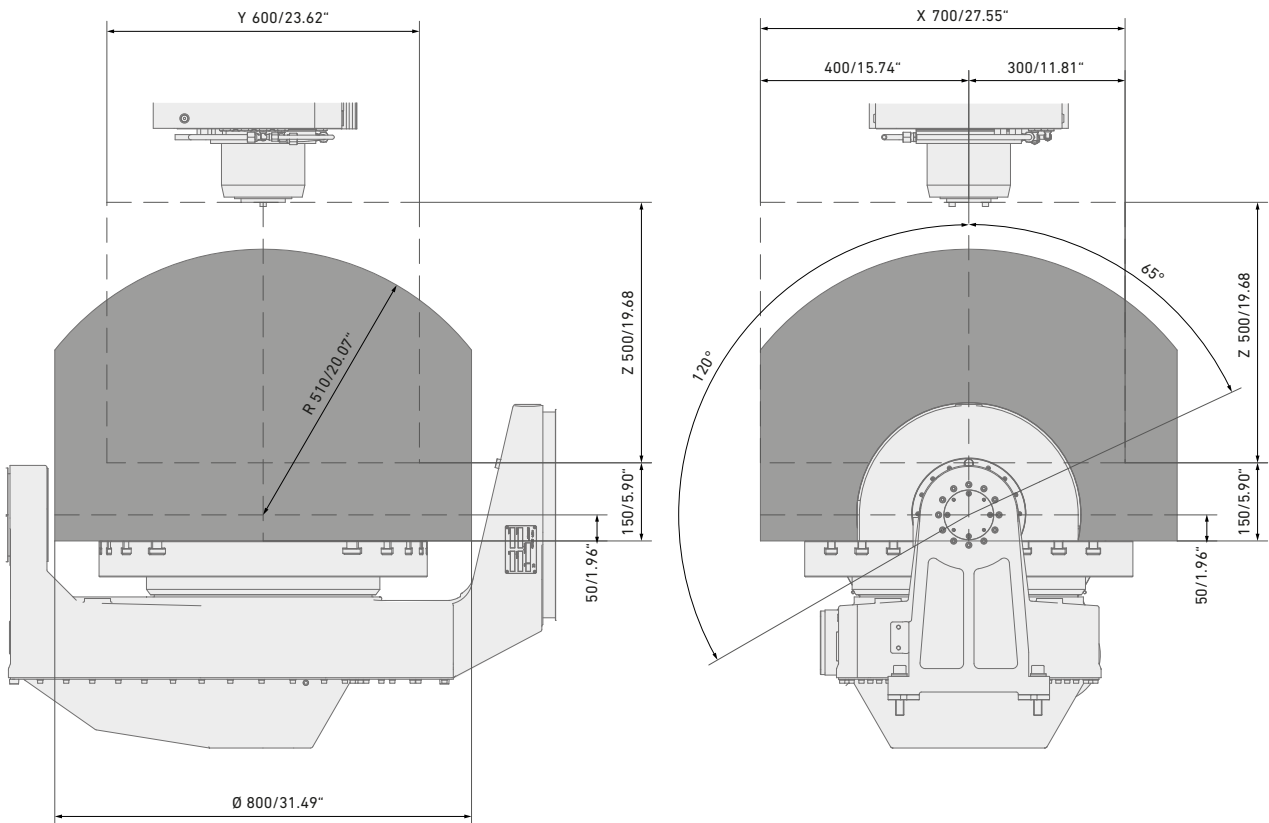

MILL E 500 U with pallet magazine

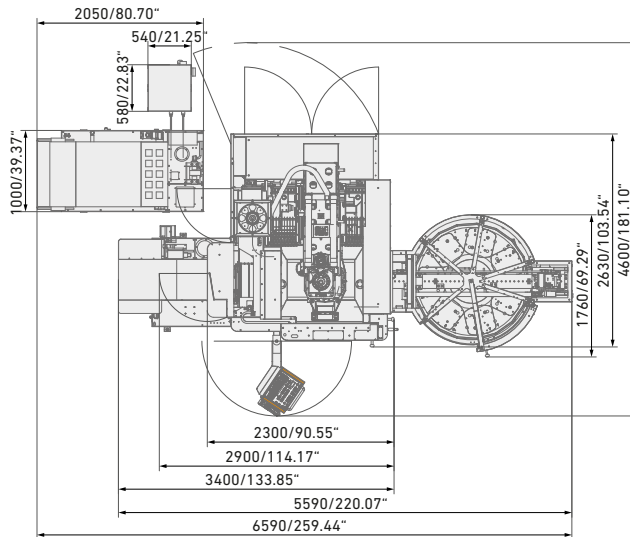
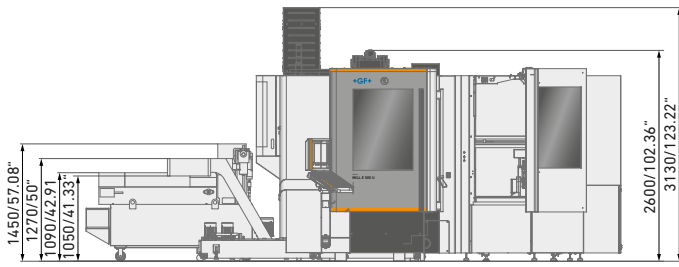

MILL E 700 U with pallet magazine

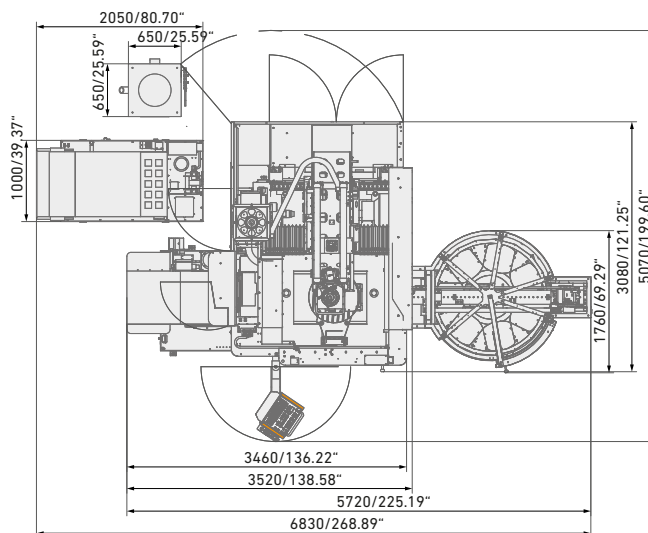
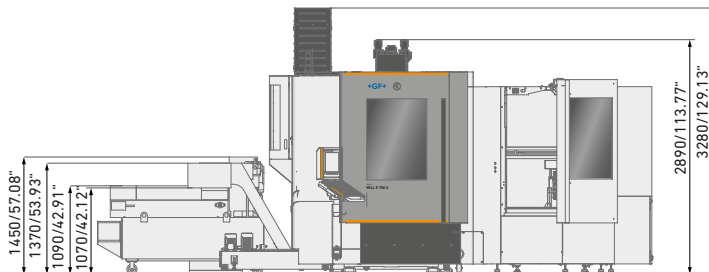

MILL E 500 U with pallet magazine and tool magazine 120, 170 or 215 tools

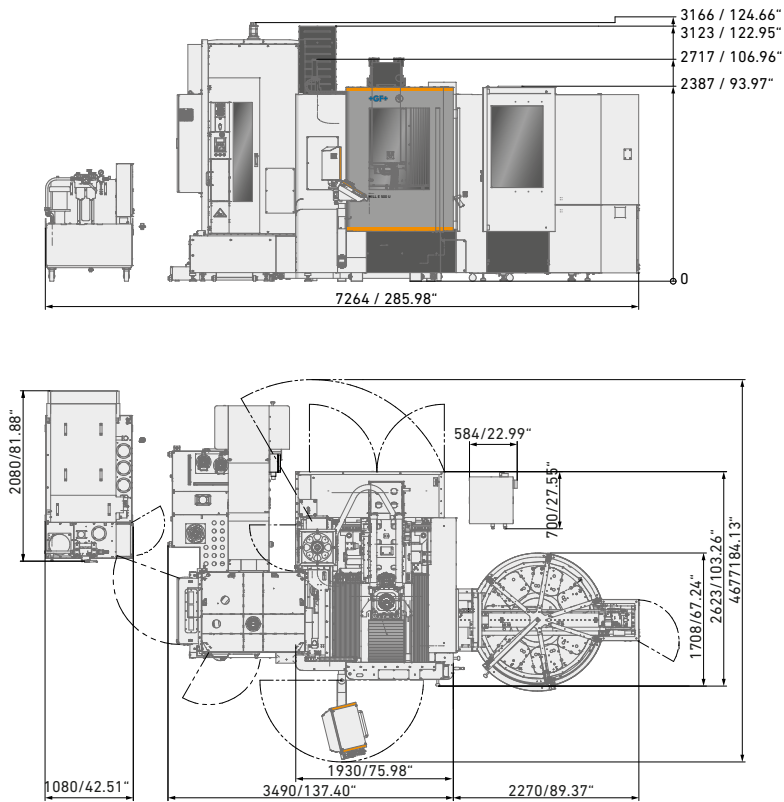

MILL E 700 U with pallet magazine and tool magazine 120, 170 or 215 tools

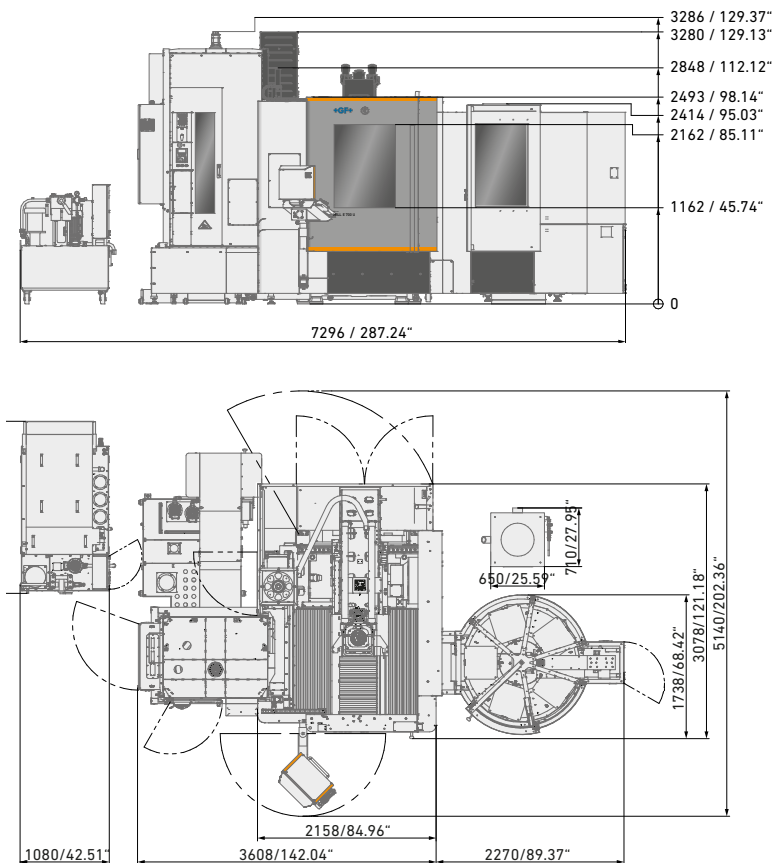

About GF Machining Solutions

Multi-technology solutions provider

Our commitment to you and your specific applications is proven by the value-adding intelligence, productivity and quality delivered by our multi-technology solutions. Your success is our chief motivator. That's why we are continuously advancing our legendary technical expertise. Wherever you are, whatever your market segment and whatever the size of your operation, we have the complete solutions and the customer-centric commitment to accelerate your success—today.

EDM (Electrical Discharge Machining)



Wire-cutting EDM

GF Machining Solutions' wire-cutting EDM is fast, precise and increasingly energy efficient. From ultraprecise machining of miniaturized components down to 0.02 mm to powerful solutions for demanding high-speed machining with respect to surface accuracy, our wire EDM solutions position you for success.

Die-sinking EDM

GF Machining Solutions is revolutionizing die-sinking EDM with features like iGAP technology to dramatically boost machining speed and reduce electrode wear. All of our die-sinking systems offer fast removal and deliver mirror finishes of Ra 0.1 µm (4 µin).

Hole-drilling EDM

GF Machining Solutions' robust hole-drilling EDM solutions enable you to drill holes in electrically conductive materials at a very high speed—and, with a five-axis configuration, at any angle on a workpiece with an inclined surface.

Tooling and Automation



Tooling

Our customers experience complete autonomy while maintaining extreme accuracy, thanks to our highly accurate System 3R reference systems for holding and positioning electrodes and work pieces. All types of machines can easily be linked, which reduces set-up times and enables a seamless transfer of workpieces between different operations.

Automation

Together with System 3R, we also provide scalable and cost-effective Automation solutions for simple, single machine cells or complex, multi-process cells, tailored to your needs.

Milling



Milling

Precision tool and mold manufacturers enjoy a competitive edge with our Mikron MILL S solutions' fast and precise machining. The Mikron MILL P machines achieve above-average productivity thanks to their high performance and Automation. Customers seeking fastest return on investment benefit from the affordable efficiency of our MILL E solutions.

High Performance Airfoil Machining

Our Liechti turnkey solutions enable the highly dynamic manufacturing of precision airfoils. Thanks to the unique performance and our expertise in airfoil machining, you increase productivity by producing at the lowest cost per part.

Spindles

As part of GF Machining Solutions, Step-Tec is engaged in the very first stage of each machining center development project. Compact design combined with excellent thermal and geometric repeatability ensure the perfect integration of this core component into the machine tool.

Software



Digitalization solutions

To drive its digital transformation, GF Machining Solutions acquired symmedia GmbH, a company specialized in software for machine connectivity. Together, we offer a complete range of Industry 4.0 solutions across all industries. The future requires the ability to adapt quickly to continual digital processes. Our intelligent manufacturing offers embedded expertise, optimized production processes, and workshop Automation: solutions for smart and connected machines.

Advanced manufacturing



Laser texturing

Aesthetic and functional texturing is easy and infinitely repeatable with our digitized Laser technology. Even complex 3D geometries, including precision parts, are textured, engraved, microstructured, marked and labeled.

Laser micromachining

GF Machining Solutions offers the industry's most complete line of Laser micromachining platforms optimized for small, high-precision features to meet the increasing need for smaller, smarter parts to support today's leading-edge products.

Laser Additive Manufacturing (AM)

GF Machining Solutions and 3D Systems, a leading global provider of additive manufacturing solutions and the pioneer of 3D printing, have partnered to introduce new metal 3D printing solutions that enable manufacturers to produce complex metal parts more efficiently.

Service + Success



We take you to new heights

Our Success Packs are designed to maximise your return on investment and empower you in your quest for success across all industrial segments. Our subscription packs feature a comprehensive range of services that guarantee the access and support you need to get the most out of your assets today, while preparing for the challenges of tomorrow. Our trusted experts backed by our latest cutting-edge, intelligent Digital Solutions, provide a full range of services.



Switzerland

Biel/Bienne
Losone
Geneva
Flawil
Langnau

www.gfms.com
www.gfms.com/ch

Europe

Germany, Schorndorf
www.gfms.com/de

United Kingdom, Coventry
www.gfms.com/uk

Italy, Agrate Brianza - MI
www.gfms.com/it

Spain, Sant Boi de Llobregat
Barcelona
www.gfms.com/es

France, Palaiseau
www.gfms.com/fr

Poland, Raszyn / Warsaw
www.gfms.com/pl

Czech Republic, Brno
www.gfms.com/cz

Sweden, Vällingby
www.gfms.com/system3r

Turkey, Istanbul
www.gfms.com/tr

Americas

USA
Lincolnshire, IL
Chicago, IL
Holliston, MA
Huntersville, NC
Irvine, CA
Woodridge, IL
www.gfms.com/us

Canada, Mississauga ON
www.gfms.com/us

Mexico, Monterrey NL
www.gfms.com/us

Brazil, São Paulo
www.gfms.com/br

Asia

China
Beijing, Shanghai,
Chengdu, Dongguan,
Hong Kong, Changzhou
www.gfms.com/cn

India, Bangalore
www.gfms.com/sg

Japan
Tokyo, Yokohama
www.gfms.com/jp

Korea, Seoul
www.gfms.com/kr

Malaysia, Petaling Jaya
www.gfms.com/sg

Singapore, Singapore
www.gfms.com/sg

Taiwan
Taipei, Taichung
www.gfms.com/tw

Vietnam, Hanoi
www.gfms.com/sg

At a glance

We enable our customers to run their businesses efficiently and effectively by offering innovative Milling, EDM, Laser, Additive Manufacturing, Spindle, Tooling and Automation solutions. A comprehensive package of services completes our proposition.

www.gfms.com

