

AgieCharmilles

CUT P

350/550
800/1250



Passion for Precision

GF Machining Solutions

When all you need is everything, it's good to know that there is one company that you can count on to deliver complete solutions and services. From unmatched Electrical Discharge Machining (EDM), Laser texturing, Laser micromachining, Additive Manufacturing and first-class Milling and Spindles to Tooling and Automation, all of our solutions are backed by unrivaled Customer Services and expert GF Machining Solutions training. Our AgieCharmilles, Microlution, Mikron Mill, Liechti, Step-Tec and System 3R technologies help you raise your game—and our digital business solutions for intelligent manufacturing, offering embedded expertise and optimized production processes across all industries, increase your competitive edge.

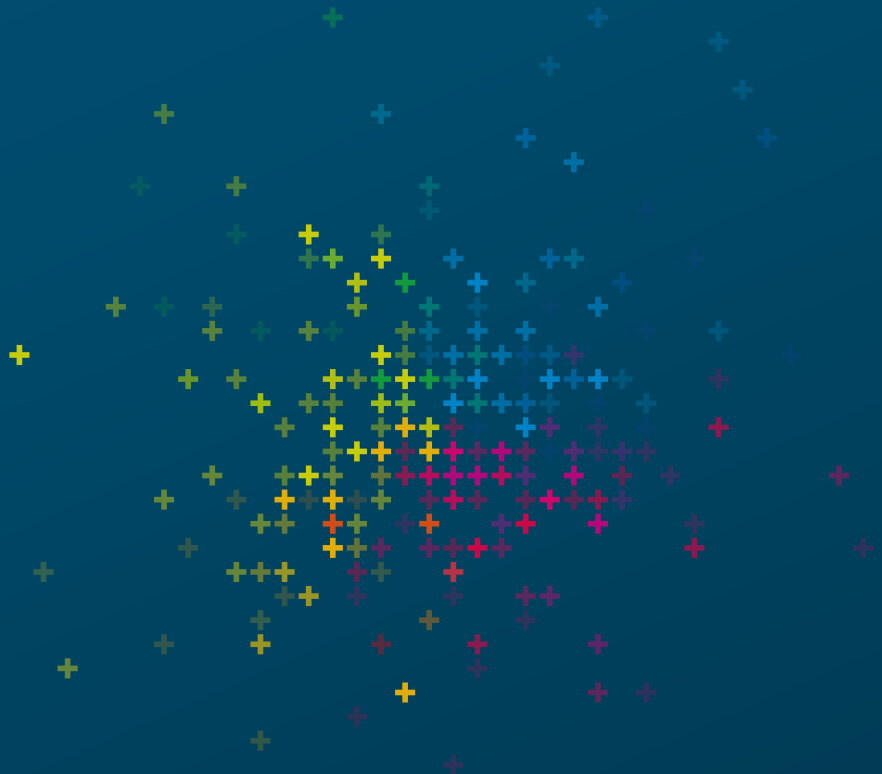

+ We are AgieCharmilles.
We are GF Machining Solutions.

Contents

4 Electronic components

6 Automotive

8 Medical

10 Industry 4.0: Step into the future

12 New CUT P series

14 A new era of autonomy

16 IPG

18 Complete range of solutions

22 Designed for rough conditions

24 AC CUT HMI

25 Optimized cost per part

26 Technical specifications

30 GF Machining Solutions

Limitless Possibilities

Face future challenges and gain access to limitless possibilities with the CUT P series. Answer your most critical applications with our complete range of solutions.

Electronic components

Accuracy is the key to your productivity

Repeatability and longer tooling life are “must haves” with component miniaturization and increasing production volumes. Achieve the accuracy, machining repeatability and finer surface finishes essential to your daily success with the new CUT P wire-cutting EDM series.

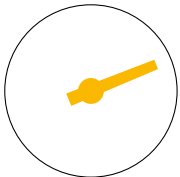

± 2 μm

positioning and
contour accuracy

Assembling more than 10 components—several millions of times—is one of the many challenges the ICT industry faces. Highly repeatable contour and positioning accuracy in production is a must.



Injection molding for camera module components



Stamping for data connectors

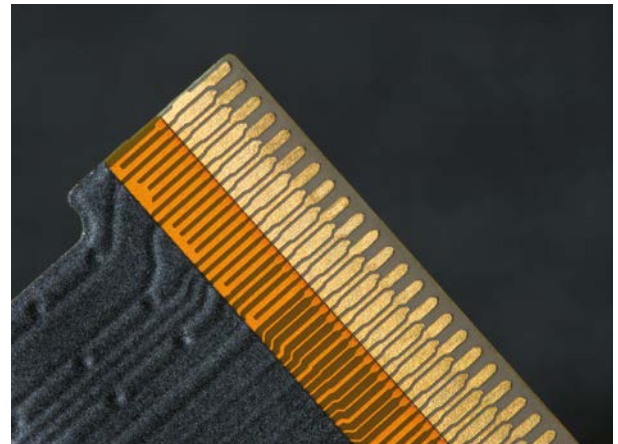

Master miniaturization

Integrating greater functionality into smaller volumes has long been a microelectronics industry characteristic, and GF Machining Solutions' has been a miniaturization master for more than 60 years. The reproducibility of the millions of plastic injection parts produced per mold is maximized by perfectly identical mold inserts. Achieve consistent precision on inserts, whatever your workshop conditions, with our superior $\pm 2 \mu\text{m}$ positioning precision, thermostabilization as variant, and very thin wire (70 μm diameter).

Accelerate your productivity

Injecting or stamping millions of parts per year requires highest productivity and reduction of manual operations and related risks of failure. The CUT P series is fully Automation ready through the entire machining process with probing module (3D setup) or automatic management of slugs. Experience a complete solution than can add more than 8,000 hours of productivity per year to your operation.

Accelerate your return on investment (ROI)

Microelectronics is a fast cycling market so you need blazing fast ROI. We support your fast ROI by delivering a solution that's always ready to work. That includes smart modules to maximize consumables efficiency and maintenance planning, and the opportunity to connect anytime with our support engineers.

Achieve low running costs

Running costs—due to the high volume of injected or stamped parts—are among the biggest influences on your cost per part. With the latest and fastest speed-oriented process, with wire consumption minimization as standard and smart modules maximizing consumables efficiency, the CUT P series reduces running costs up to 20 percent compared to earlier models.

Automotive

Optimize your workflow, reduce your time to market

Shorter time to market, larger product portfolios and zero-defect manufacturing call for shorter, more efficient manufacturing flows, more flexible production lines, and more reliable processes. Overcome these challenges with the CUT P series' machining quality and efficiency solutions to optimize your production tool.



**up to
20%**

speed increases
compared to previous
generation



Injection molding for car interiors

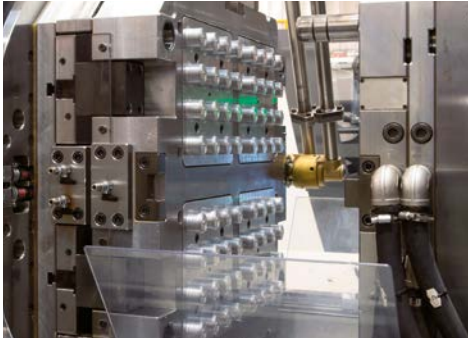

Lower cost per part, greater mold lifetime

Reduce the cost per part and increase the lifetime of your mold with higher accuracy, machining repeatability, and finer surface finishes. With contour precision down to $\pm 2 \mu\text{m}$, extreme repeatability and surface finishes down to $\text{Ra } 0.08 \mu\text{m}$, more cycles are possible; at the same time, the new Intelligent Power Generator (IPG) increases process speed by 20 percent compared to earlier, similar machines.

Reduced time to market

Being a preferred supplier is directly linked to your ability to support the right quality products in the shortest time possible. With the new CUT P series, you have a complete production solution to do just that. Increase your efficiency with tooling for part setup outside of the machine, with Automation, automatic 3D setup, or workshop management software.

Increase flexibility, reduce scrap

Master two absolutely contradictory trends: The market requires an ever-increasing number of products and variants but has no tolerance for manufacturing defects. Ramp up your flexibility while reducing the risk of failure with the CUT P series' thermostabilization, advanced accuracy, and automated slug management solutions.

Part production for gear boxes

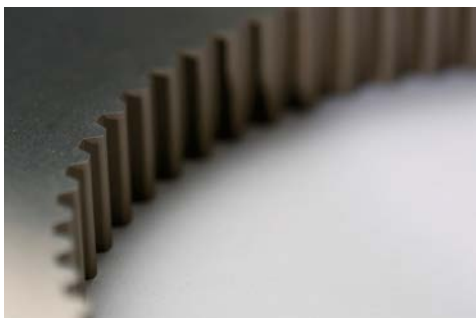

Connector and contact stamping

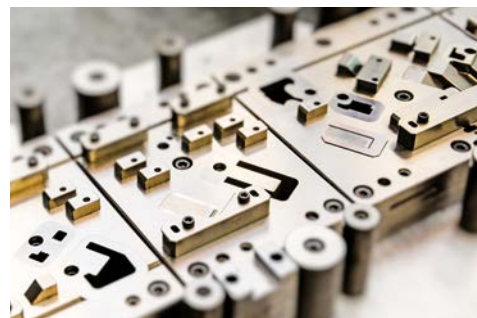

Medical

Increase your design possibilities

Contrary to common belief, EDM has many strong advantages over more traditional medical industry manufacturing methods. With wire EDM as your solution, you easily execute complex geometries while benefitting from lower tooling costs, absence of machining forces, controlled biocompatibility, and a wide variety of Automation choices.

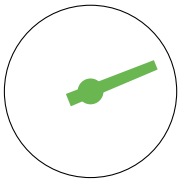

100%

open to more flexible designs compared to traditional manufacturing techniques such as milling and turning



Production efficiency

With the increasing use of difficult-to-machine materials such as stainless steels, cobalt chromium and titanium, wire EDM presents substantial advantages versus traditional machining technologies. Wire EDM prevents expensive cutting-tool costs and delivers absolutely burr-free parts regardless of part geometry. As machining forces are totally absent, part geometries are unaltered by the process and the clamping remains very simple.

Part production for spinal implant



Traceability

Industry regulations mandate full traceability of the manufacturing process, and our CUT P series allows you to adhere to the ISO 13485 medical standards. You can achieve total process control and traceability with our smart modules controlling consumables and our rConnect module ensuring permanent communication between the machine and the workshop manager.

Part production for cervical implants



Biocompatibility

Producing implantable parts implies manufacturing biocompatible technical materials. Perfect surface homogeneity is required, since no surface functionality alterations are permitted. For these purposes, the new digital IPG allows precise, fully controlled and reproducible surface integrity. For applications such as implants, our solution allows machining with tungsten wire to prevent any contamination of the part surface, providing full compliance with medical standards.

Surgical tools



Reduce risks

Avoiding errors means reducing the human factor in the manufacturing process. During the EDM process for insert machining, GF Machining Solutions provides fully Automation-ready solutions, from a robot for Tooling to a dedicated module for automatic slug management.

Injection molding for medical consumables

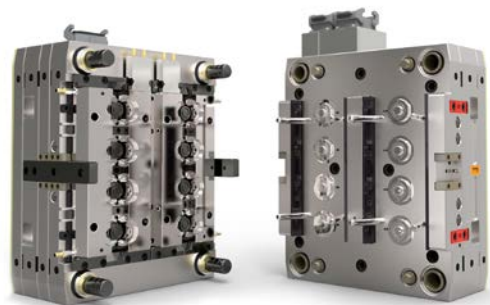

* Injection molds for packaging
Braunform GmbH

Industry 4.0: Step into the future

Availability is key for your business

The time you spend cutting is the time you are making money. That's why GF Machining Solutions optimizes your productivity and machine availability with SMART and connected solutions.

Manage your resources

Increase your efficiency with smart consumables

At the forefront of the Internet of Things, GF Machining Solutions presents SMART consumables, integrating RFID chips into wire consumables to offer several efficiency-boosting benefits:

- The machine automatically recognizes and parameterizes itself to work with the wire you just installed. The risk of error is eliminated and consumables are more quickly replaced.
- Increases machine availability by avoiding unnecessary breakdowns when wire is finished
- Reduces your stock to the minimum
- All spool data is registered and linked to the job to guarantee your complete process traceability



Wire type: AC Cut VH
Remaining wire: 5,800 m
Okay for job

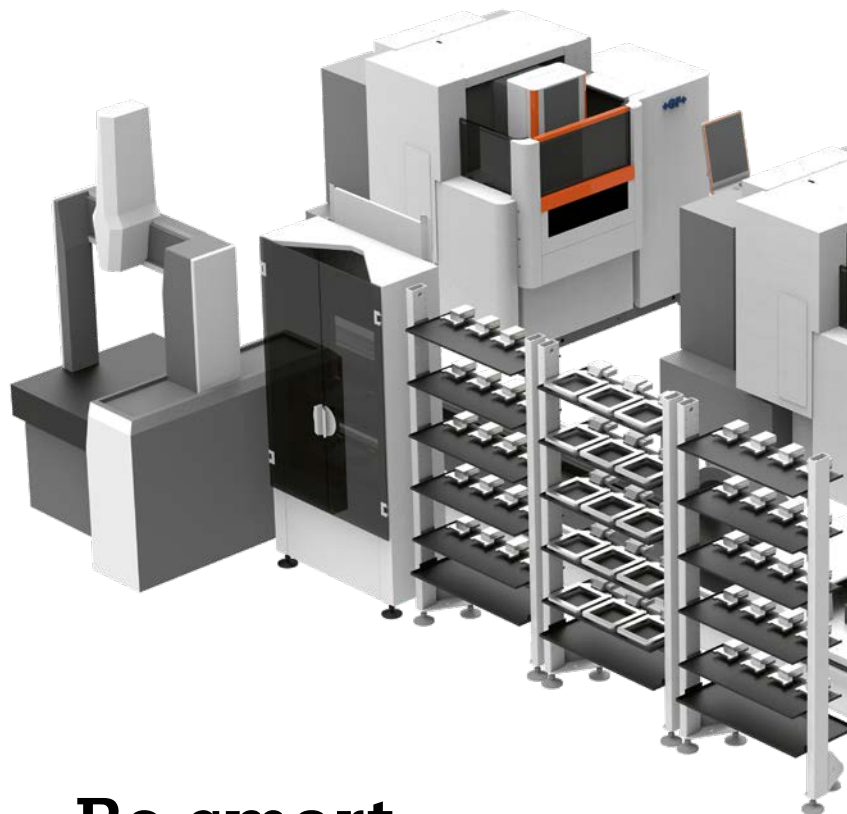

Be smart, be connected

Establish your autonomy

WorkShopManager and CellManager take you to the next level of autonomy.

Software for administering and surveying the process of automated cells.

- Prepares jobs out of the machine on a pallet, measures with a CMM and automatically transfers the setup measurements to the machine to increase productivity
- Visualizes the loaded work and process status for process optimization
- ID chip management for highest process security

Ensure quality with monitoring and traceability

eTracking digitizes your process monitoring

- Ensures early quality failure detection by monitoring all machining and generator parameters
- Prevents high scrapping losses by setting up alarms and related actions if process deviates from standard conditions
- Delivers full process traceability for highly critical applications such as medical or aerospace

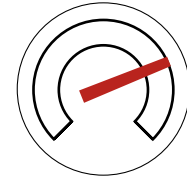

Injection pressure
Water temperature
Short circuit
Feed rate



rConnect



Industry 4.0

GF Machining Solutions' wire EDM is completely aligned with Industry 4.0 and your need to optimize production processes with intelligent information use. We understand that machines are part of a larger puzzle consisting of creation, simulation and post-processing stages. That's why we collaborate with multiple partners to connect all stages and make them complementary.

Closer support for you

Secure highest availability with rConnect

rConnect comprises our modular digital services. From Live Remote Assistance ensuring maximum machine uptime via process improvement modules to predictive maintenance and monitoring, rConnect keeps you connected anytime, wherever you are.

- Detailed information about your machine with your cockpit per machine
- More uptime for your machinery
- Direct and interactive access to our service specialists
- Faster identification of potential problems
- Secure connection based on the latest technology—certified by TÜViT



New CUT P series

Success relies on passion for details

Retractable grid
Fast access to the working area

Thermostabilization
Cut and preserve the accuracy all day and all night

Centralized greasing
Fast maintenance

Rhenocast
Stable results over time and temperature, whatever the part



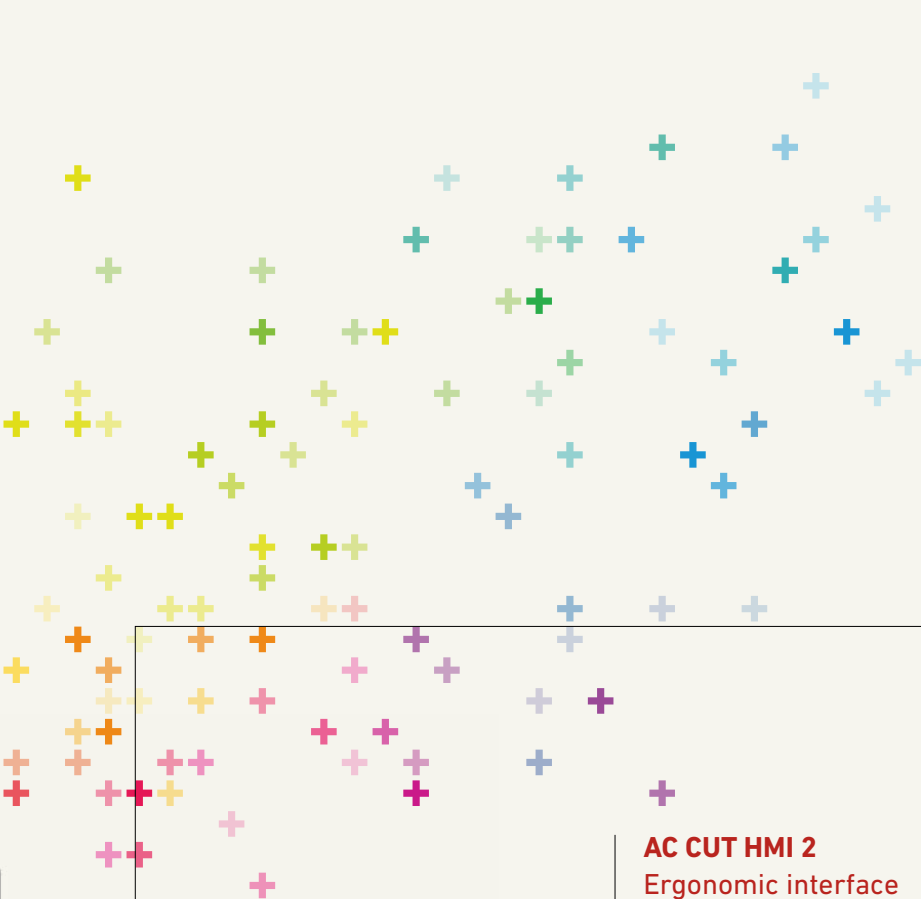

IPG

Best generator on the market allowing surface finish down to Ra 0.08 μm , finest part rectitude with lateral servo control while offering ultimate machining speed



AC CUT HMI 2

Ergonomic interface designed with and for the user

Eco wire mode

Reduces wire consumption up to 30 percent

Wire speed optimization
during measuring cycles

* Some elements may be available as options or unavailable on some models

A new era of autonomy

Enrich your potential

Productivity, part cost and flexibility are your top priorities. GF Machining Solutions stands out as your partner from project conception to the complete installation of your production solution. Cut processing time by up to 20 percent with our slug management solutions.

Automatic Slug Management (ASM)

For the first time, the wire EDM process becomes completely autonomous. Conventional slug extraction can represent up to 20 percent of the total processing time and requires manual intervention. By automating this step, you reduce manual intervention and gain processing time.



Automatic Slug Welding (ASW)

Easy to configure, the new Automatic Slug Welding functionality automatically welds the core to the cavity, leaving a micro-fixture using a reverse erosion process.

This allows you to easily remove the core by a manual tap before the finishing cuts and reduce processing time by up to 10 percent and manual intervention time by up to 90 percent.

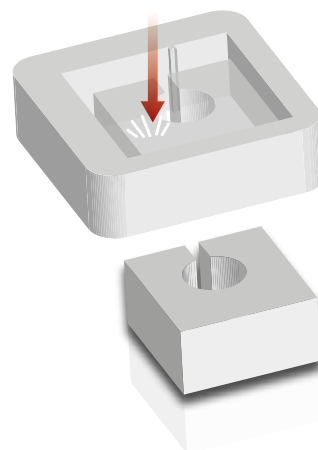

Solutions adapted to your business

To match your business and environment, go for our Tooling and Automation solutions to accommodate production changes and maximize your throughput.

Begin

Increase your flexibility in handling workpieces of various sizes. Ensure your process repeatability. One-minute setup with pallets. Every minute that can be converted from internal to external setting time increases the machining time. Gain up to 50 percent productivity in a single-shift workshop.

Increase productivity by 500% with full software-controlled Automation

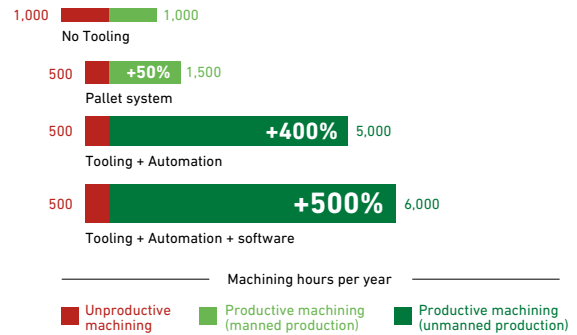

Expand

Linking a WPT1+ with two wire EDM machines along with our Automation programs will increase your capacity and expand your autonomy while increasing your productivity with masked time part preparation. Get faster payback on the investment by up to a factor of two.

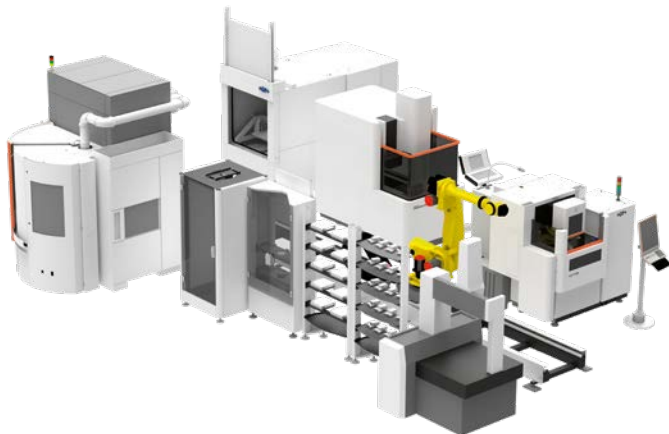

Industrialize

Boost your competitiveness. Achieve complete industrialization by combining wire EDM with other technologies to master your process from A to Z around the clock, seven days a week. Our software management solutions will handle all of the production data, allowing you to multiply your effective productive machining time up to sevenfold.

Cut cost per part by up to 20 percent

EXPERT systems: a legacy at the service of your results



POWER-EXPERT

POWER-EXPERT prevents wire breakage on parts with variable heights while ensuring the highest speed technically achievable. In addition, during height variations, the intelligent module ensures a smooth generator transition to guarantee no lines on the part surface. You achieve highest part quality in molding applications.



SURFACE-EXPERT

SURFACE-EXPERT controls the sparking parameters during the finishing stage on parts, so you obtain the finest surface finish and minimize polishing while maximizing part quality.



WIRE-EXPERT

No matter the height of the part, WIRE-EXPERT will provide a dynamic control of the wear of the wire to ensure the highest geometrical accuracy.



PROFIL-EXPERT

Gain perfect control of fine details. No matter the contour or machined height of the workpiece, PROFIL-EXPERT will automatically adapt the machining parameters the machining path of rough and skim cuts to guarantee the highest profile accuracy and geometry.

Up to 20 percent cutting speed increase

With our latest generation Intelligent Power Generator's productivity reaches its quintessence. Combined with AC Cut VS+ wire, you reduce your cost per part while increasing the number of parts produced.

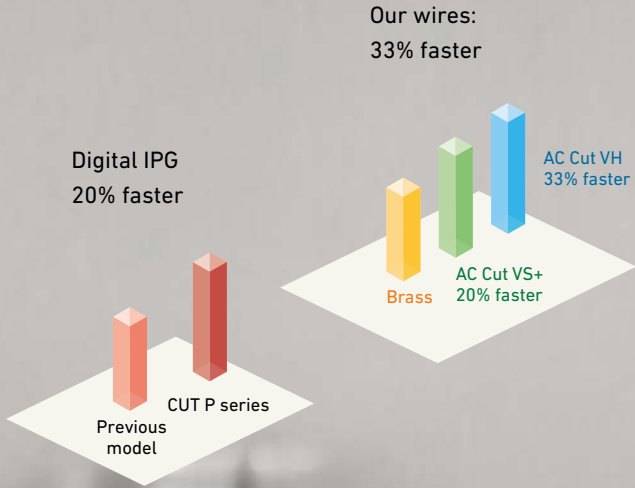

Fewer cuts for improved surface finish

Achieve surface finishes as fine as Ra 0.1 µm in minimal cutting time—up to 20 percent faster than before.

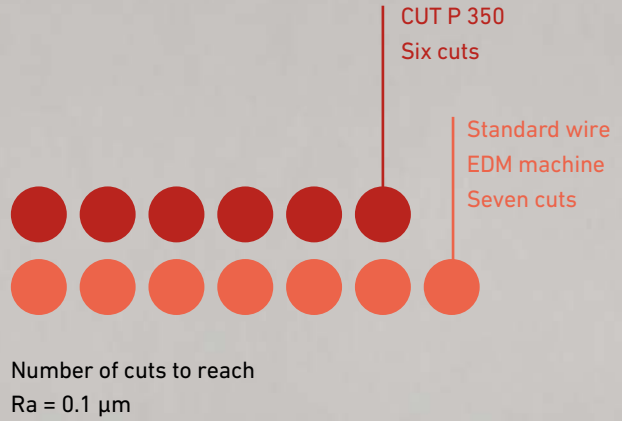

Over 600 dedicated processes to produce the best result—whatever your need

With more than twice the number of dedicated processes as a standard wire EDM machine, our CUT P series' 600-plus technologies mean you can meet any objective on your parts. Our technologies cover a wide range of parts, from less than 1 mm to 800 mm in height, and materials from steel, carbide and copper, to aluminum, titanium, polycrystalline diamond (PCD) and graphite. Our complete wire range perfectly addresses your every need, whether it's quality, speed or cost.

Materials available



Machining heights

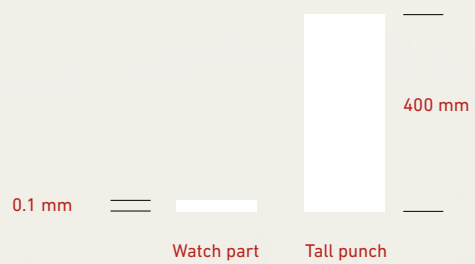

Wires available

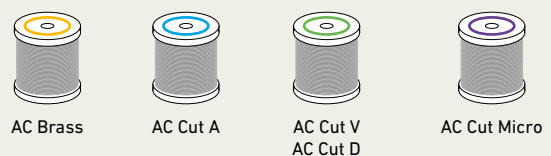

wire diameters
0.07 mm | 0.1 mm | 0.15 mm | 0.2 mm | 0.25 mm | 0.3 mm

Complete range of solutions

The answer to your daily challenges

From a few grams to six metric tons, and whether you are producing surgical tools or aluminum die-casting molds for automotive, we offer a complete product line to satisfy your needs.



Outstanding mechanical stability

Thanks to the Quadrax® and fixed table design of the machine, accuracy and repeatability are ensured, regardless of part size and weight.

up to **6,000 kg**



up to **800 mm**



Advanced thermostabilization

Temperature variation is the number one enemy when high accuracy is expected. Thermal regulation can be integrated to maintain temperature consistently with $\pm 0.2^{\circ}\text{C}$ even in the most unstable workshops. Accuracy and repeatability remain at the highest level.

Available as a variant on CUT P 350 and CUT P 550

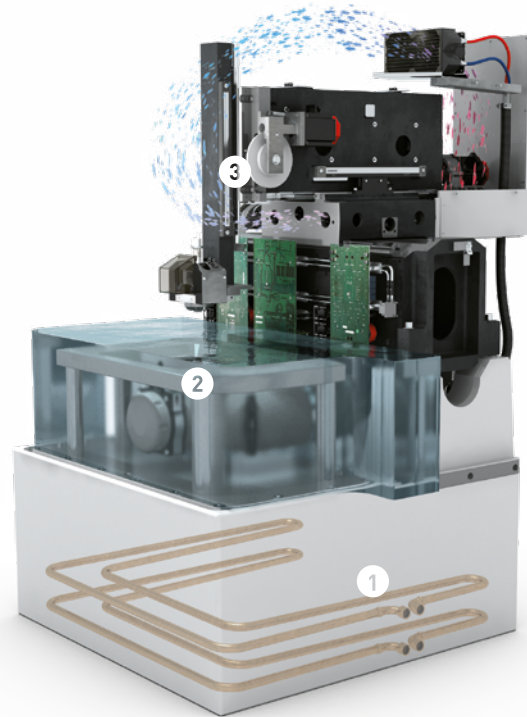
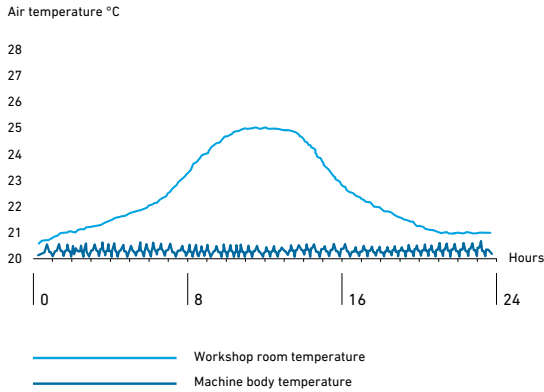

- 1 Water circulation in the Rhenocast machine base
- 2 Working area
- 3 Air conditioning in the cabin

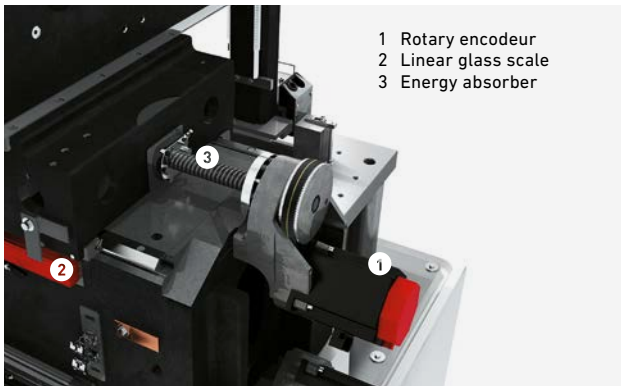

Collision protection

Prevent costly machine maintenance and ensure long-term accuracy and reliability with our unique collision protection system.



TAPER-EXPERT

Master accuracy on small to large tapers from 0° to 30° (45° as an option). Thanks to TAPER-EXPERT and the unique Quadrax® design, the position of the wire is corrected—depending on the angle, and even on the largest angles—in real time and during machining. Secure your accuracy below one minute of angle accuracy (and even less than 20 seconds of angle accuracy with complete calibration).

Mastering of large tapers

TAPER-EXPERT takes advantage of the unique Quadrax® design to allow very precise machining of tapers with angles varying from 0 to 30°. It corrects in real time and during machining the position of the wire depending on the angle. The surface quality is the same as that in cylindrical machining.

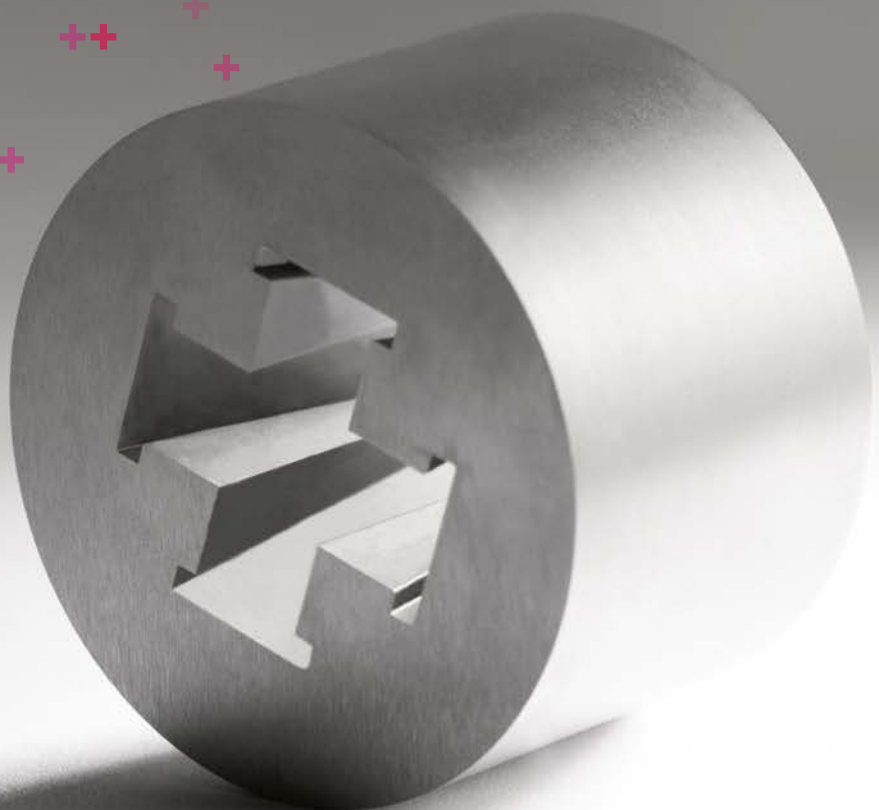
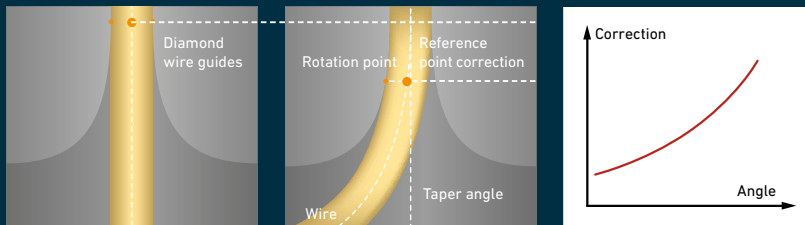



Most advanced threading on the market

Wire threading is one of the most delicate steps in the wire EDM process. Effective wire preparation is the key to achieving successful threading in all circumstances, regardless of the wire quality. Our annealing and stretching of the wire guarantees you most reliable machining, even for long runs, with no interruptions.



Advanced accuracy

Guarantee your precision on large multiple-die tools with advanced accuracy. By reducing assembly tolerances and adding calibration procedures positioning accuracy goes down to $\pm 2 \mu\text{m}$.



Productivity with advanced setup

No matter how complex the part to be cut by wire EDM, the positioning and control of every step of the machining process are essential to ensure quality. Customized measuring cycles can be manually or automatically performed even on the most inaccessible part shapes.

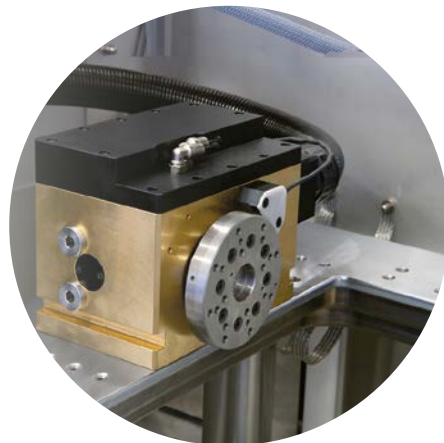

Rotary axes

Further enlarge your range of applications. We provide various types of rotating axes allowing controlled rotation simultaneously with the other axes.

Other available variants

Wire chopper

Chromium hardened table

3D Setup

Optical Measuring System

Other available options

Big spool 25 kg

4-color stack light

Designed for rough conditions

Outstanding in every situation

We strive to provide a solution that performs highly in every single situation and for every type of application, whether it's in medical, electronic components (EC) or automotive.



**Perfect molded part results
in automotive**

Experienced high quality on injected parts and longer tooling life, thanks to our 30 years of tapered parts mastery.

1x tapered die and 4x tapered inserts

Application: injection molding

Dimensions when all 5 parts will
be assembled: $\varnothing 42 \times 40$ mm

Material: steel

Wire: AC Cut D $\varnothing 0.25$ mm

Surface finish: Ra $0.5 \mu\text{m}$

Contour accuracy: $< \pm 5 \mu\text{m}$

Taper accuracy: $< 10''$

Productivity for ICT

Achieve perfect surface without machining lines on complex stepped parts in less machining time than before.

Application: mold and die insert
Dimensions: 60 x 60 x 20 mm
Material: steel
Wire: AC Brass 900 Ø 0.2 mm
Surface finish: Ra 0.3 µm
Contour accuracy: ± 2 µm

Passion for precision in automotive

Guarantee your accuracy on applications with complex shapes with our fine wire solutions.

1x punch and 1x die
Segment: Automotive
Application: sintering punch and die
Dimensions die: 40 x 40 x 20 mm
Dimensions punch : Ø16 x 50 mm
Material: steel and carbide
Wire: AC Cut AH Ø 0.1mm
Surface finish: Ra 0.2 µm
Contour accuracy: < ± 2 µm

Whatever your mold size, we offer highest accuracy and confidence for tools and expensive parts.

Application: injection molding
Dimensions: H 200 mm
Material: steel
Wire: AC Cut AH Ø 0.25 mm
Surface finish: Ra 0.35 µm
Contour accuracy : < ± 10 µm

The solution for your most complex applications

Machine ultra-fine geometries for multi-cavity molds in electronics.

Application: injection molding
Dimensions: approximately 100 x 6 x 40 mm
Material: steel
Wire: AC Cut AH Ø 0.1 mm
Contour accuracy: < ± 2 µm

AC CUT HMI

Where ergonomics meet efficiency

With a wide range of new functionalities, the AC CUT HMI brings user efficiency one step further through an intuitive and ergonomic touchscreen interface. Improve your daily life and increase your productivity for your mold and die applications.

Simple file management

Design around the use, manage folders and files, organize job execution and access AC CAM EASY in the most ergonomic manner.

Configuration and maintenance

From a single access panel, efficiently manage your machine so that it's always ready to work.

Easy programming

Whether you program on the machine or import from CAD/CAM software, our HMI is designed to be logical and simple to use.

eConnectivity functions

Connect your machine to your workshop and get a better management of your production tool.

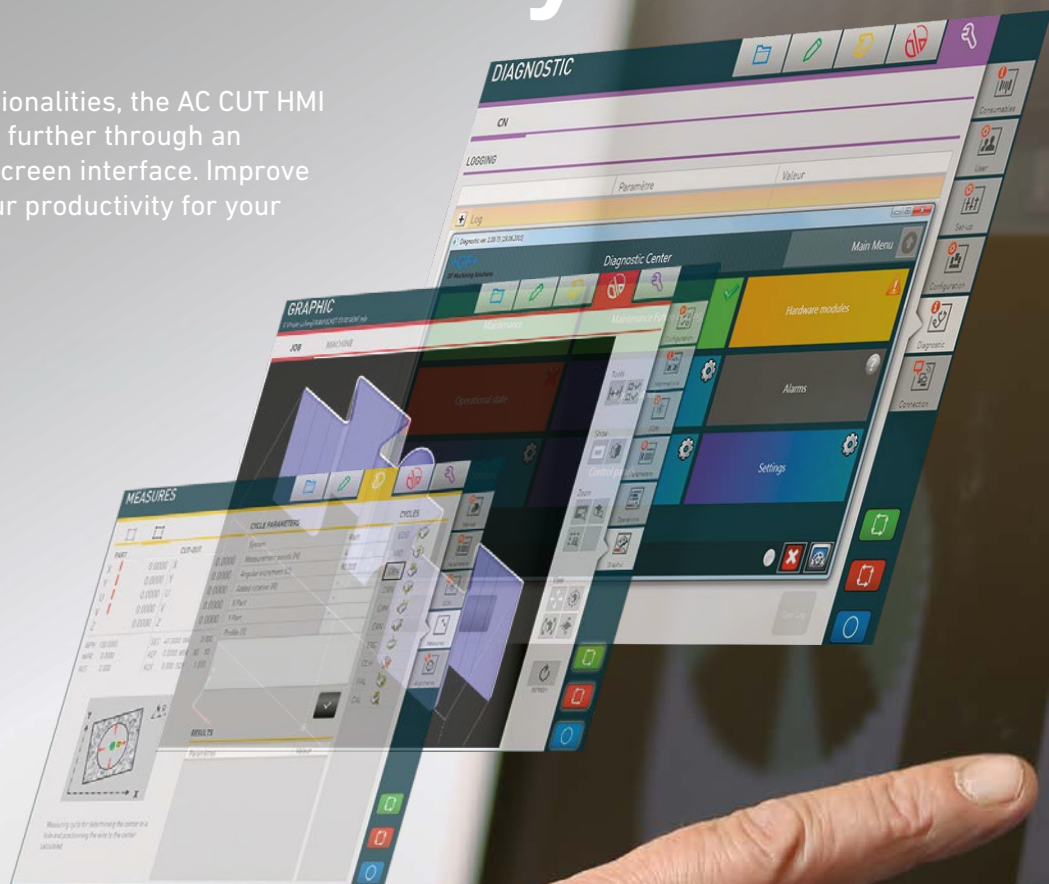

19"

Intuitive touchscreen
Nineteen-inch vertical
touchscreen designed to
simplify your daily life

Optimized cost per part

Conserve your resources

We aim to reduce your total cost of ownership. As important as your machine investment is, even more important are the benefits it will deliver during its lifetime.

More autonomy

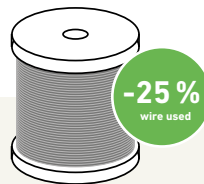

Up to 25 percent reduced wire consumption versus previous generation

Thanks to optimized wire feed rate and faster technologies with the IPG, you can significantly reduce the highest cost-intensive influence on running costs.

Double your autonomy

Increase your autonomy and let the machine work for you during the weekends by using 25 kg spool which is also compatible with Automation.

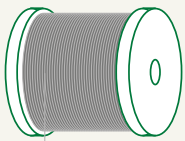

25 kg spool increases autonomy

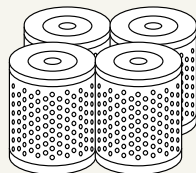

Double your autonomy with four filters

Less running costs

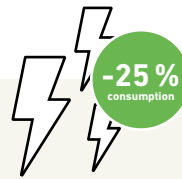

Econowatt: consume 25 percent less power

Save on energy costs and reduce your ecological footprint with our Econowatt module managing your machine's electrical power. Your result: no wasted energy during unattended machining. The power supply is reduced to the minimum or disconnected—depending on machine parameters—when machining is finished or interrupted. Automatic restart is programmed in alignment with your workshops working hours, and the machine comes on in time for sufficient thermostabilization when the workshop opens.

20 percent speed increase means 20 percent lower running costs

Higher performing machines will have a strong impact on your running costs by reducing them accordingly. Invest in advanced wires such as AC Cut AH and gain as much as processing time versus standard wires.



More productivity

Benefit from:

- Fivefold machining time increase with Automation
- Ninety percent less operator Intervention time with ASW
- Twenty percent less processing time with ASM
- Ten percent less processing time with automatic setup

Let your skilled workforce focus on high added value tasks while the machine works alone with our Automation-oriented options. Plus, faster operation means lower running costs.



+500% machining time with Automation

Technical specifications



CUT P 350



CUT P 550



CUT P 800



CUT P 1250

		CUT P 350	CUT P 550	CUT P 800	CUT P 1250
Machine					
Type of machining		Submerged wire-cutting	Submerged wire-cutting	Submerged wire-cutting	Submerged wire-cutting
Dimensions of complete equipment (*)	mm (in)	2050 x 2234 x 2154 (80.71 x 87.95 x 84.80)	2600 x 2640 x 2340 (102.36 x 103.94 x 92.13)	2670 x 2870 x 2645 (105.12 x 112.99 x 104.13)	4851 x 4185 x 3725 (190.98 x 164.76 x 146.65)
Total weight of equipment (without dielectric)	kg (lbs)	2450 (5401)	3300 (7275)	6300 (13860)	17000 (37479)
Machining area					
Vertical sliding door		Automatic	Automatic	Automatic	Automatic
Max. workpiece dimensions (*) (Top load)	mm (in)	1000 x 150 x 220 (39.37 x 5.90 x 8.66)	1200 x 275 x 400 (47.24 x 10.80 x 15.75)	1450 x 950 x 510 (57.08 x 37.40 x 20.07)	2300 x 900 x 750 (90.55 x 35.43 x 29.52)
Max. workpiece dimensions (*) (Front load)	mm (in)	800 x 550 x 220 (31.50 x 21.65 x 8.66)	1000 x 700 x 400 (39.37 x 27.56 x 15.75)	1450 x 550 x 510 (51.08 x 21.65 x 20.07)	2300 x 1300 x 750 (90.55 x 51.18 x 29.52)
Max. workpiece weight	kg (lbs)	750 (1653)	1500 (3307)	3000 (6614)	6000 (13228)
Dimensions of table (**)	mm (in)	680 x 450 (26.77 x 17.72)	900 x 600 (35.43 x 23.62)	1240 x 800 (48.8 x 31.5)	1956 x 1324 (77 x 52.13)
Floor-to-table distance	mm (in)	1000 (39.37)	1000 (39.37)	1000 (39.37)	1300 (51.18)
Total volume of dielectric	l (gal)	700 (185)	1300 (344)	1700 (450)	5000 (1321)
X, Y, Z and U, V axes					
X, Y, Z travel (*)	mm (in)	350 x 220 x 220 (13.77 x 8.66 x 8.66)	550 x 350 x 400 (21.65 x 13.77 x 15.75)	800 x 550 x 510 (31.5 x 21.65 x 20.07)	1250 x 850 x 700 (49.21 x 33.46 x 27.56)
U, V travel (**)	mm (in)	350 x 220 (13.77 x 8.66)	550 x 350 (21.65 x 13.77)	800 x 550 (31.5 x 21.65)	1250 x 850 (49.21 x 33.46)
Max. speed (X, Y and U, V axes)	m/min	3 (9.8 ft/min)	3 (9.8 ft/min)	3 (9.8 ft/min)	3 (9.8 ft/min)
Integrated Collision Protection (ICP)		Standard on 5 axes	Standard on 5 axes	Standard on 5 axes	Standard on 5 axes
Taper machining					
Max. taper	°/mm	± 45/220 (± 30/220 standard)	± 45/400 (± 30/400 standard)	± 45/510 (± 30/510 standard)	± 30°/800
	°/in	± 45/8.66 (± 30/8.66 standard)	± 45/15.75 (± 30/15.75 standard)	± 45/20.07 (± 30/20.07 standard)	± 30°/31.5
Electricity supply (machine)					
Three-phase input voltage	V	380/400	380/400	380/400	380/400
Maximum consumption	kVA	12	12	12	12

CUT P 350 / CUT P 550 / CUT P 800 / CUT P 1250

Dielectric

Paper filters		CUT P 350/550/800: 2 cartridges (option 4 cartridges) CUT P 1250: 6 cartridges
Temperature control of clean water tank	°C	± 0.1 (± 2 °F)
Total volume of deionization resin (option)	l	20 (5.3 gal)
Max. injection pressure	bar	20

IPG Generator

Protection against electrolytic effects		From roughing through to finishing
Max. cutting speed	mm ² /min	400 (37.7 in ² /hour)
Min. finishing	µm Ra	CUT P 350/550/800: 0.08 (3.2 µ-inch RMS) CUT P 1250: 0.2 (8 µ-inch RMS)

Numerical control

Position measurement system / resolution		Linear glass scales / 0.050 µm (0.000002 in.)
Architecture		PC multiprocessors
Operating system		Windows
Screen		LCD 19" TFT (touch screen)
Keyboard, mouse		Touch screen, yes
Remote control		Standard
Part program capacity		4 MB
Ethernet, USB ports		Standard

CUT P 350 / CUT P 550

CUT P 800

CUT P 1250

Wire circuit

Wire diameters available	mm in	0.33 to 0.07 (0.33 to 0.15 std) 0.013 to 0.003 (0.013 to 0.006 std)	0.30 to 0.15 0.012 to 0.006	0.30 to 0.15 0.012 to 0.006
Type of wire guides		Closed diamond type without clearance	Closed diamond type without clearance	
Permissible weights and types of spool (ISO standards)	kg lbs	1.6 (K100) to 8 (K160) 3.52 (K100) to 17.6 (K160)	25 (K250) 55 (K250)	25 (K250) 55 (K250)
Permissible weights and types of spool (JIS standards)	kg lbs	3 (P3) to 5 (P5) 6.6 (P3) to 11 (P5)	3 (P3) to 5 (P5) 6.6 (P3) to 11 (P5)	
Programmable wire tension	daN	0.3 to 3	0.3 to 3	0.3 to 3
Automatic threading for wire	mm in	0.33 to 0.07 (0.33 to 0.15 std) 0.013 to 0.003 (0.013 to 0.006 std)	0.30 to 0.15 0.012 to 0.006	0.30 to 0.15 0.012 to 0.006
Automatic rethreading for wire	mm in	0.33 to 0.07 (0.33 to 0.15 std) 0.013 to 0.003 (0.013 to 0.006 std)	0.30 to 0.15 0.012 to 0.006	0.30 to 0.15 0.012 to 0.006

Options

Thermostabilization		Water in machine basis / Air in cabine (UV axis)	—	—
Large spools	kg (lbs)	16 (35.2) K200, 25 (55) K250	—	45 (100)
TAPER-EXPERT		Advance	Advance	Advance
e-Connectivity		Option	Option	Option
Extended taper cutting		From 30° to 45°	From 30° to 45°	—
Used wire processing		Wire chopper	Standard	Standard
Rotating axes		Index or servo-control	—	—
Automatic Part Leveling		3D SETUP	—	—
Optical measuring system		OMS	—	—
3D probing		Renishaw probe	Renishaw probe	—
Alarm lamp		Four color stack light	Four color stack light	Four color stack light
Advanced accuracy		< ± 2 µm positioning	—	—
Automatic slug management		Option	Option	—
E-tracking		Option	Option	Option
Centralized automatic greasing		Manual (standard) Automatic (option)	Manual (standard) Automatic (option)	—

CUT P 350

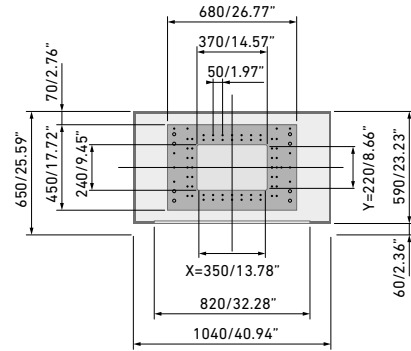
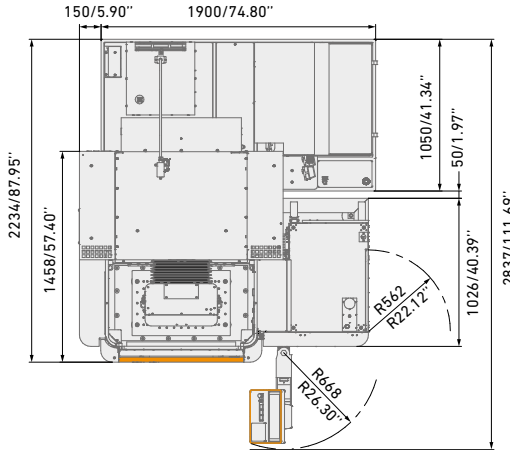
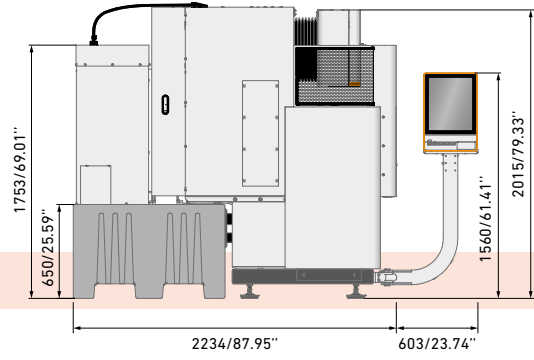
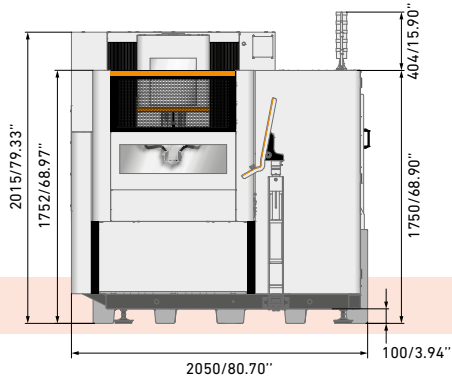

CUT P 550

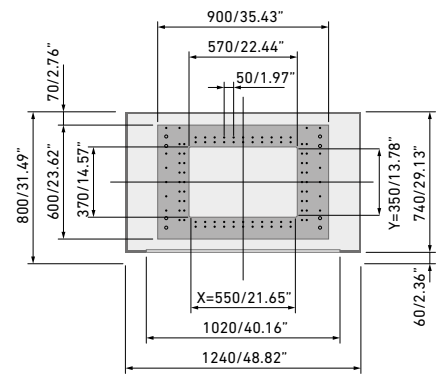
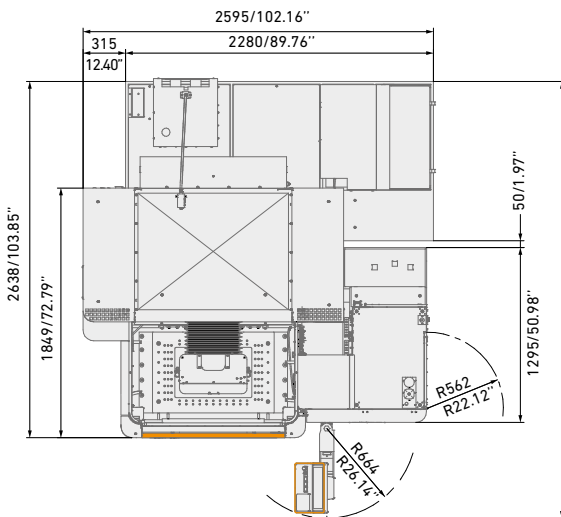
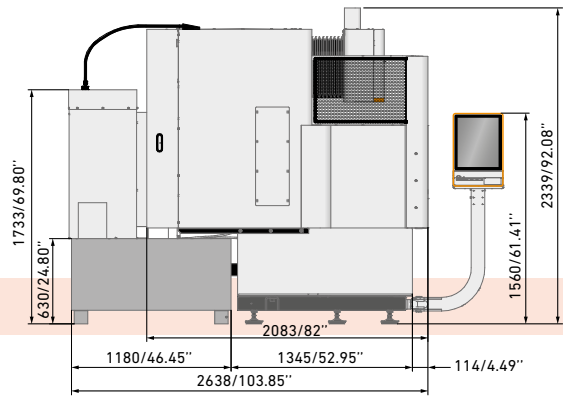
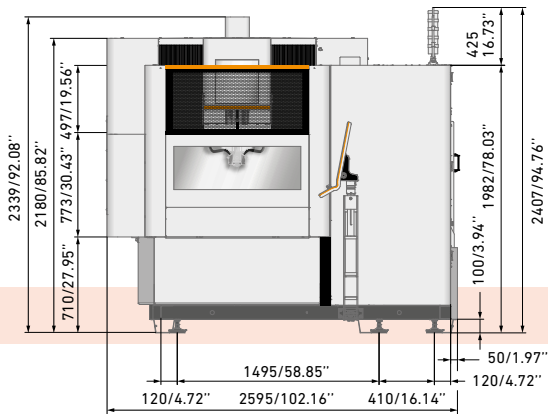

CUT P 800

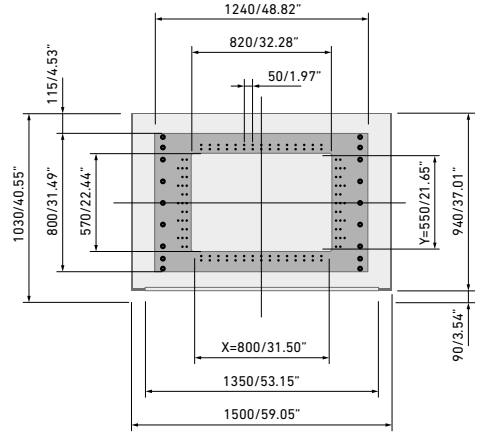
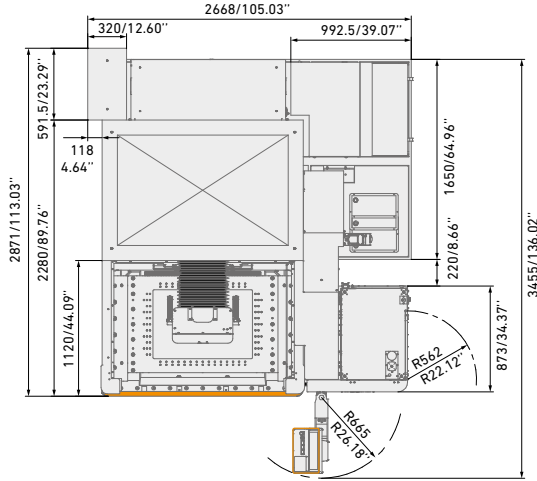
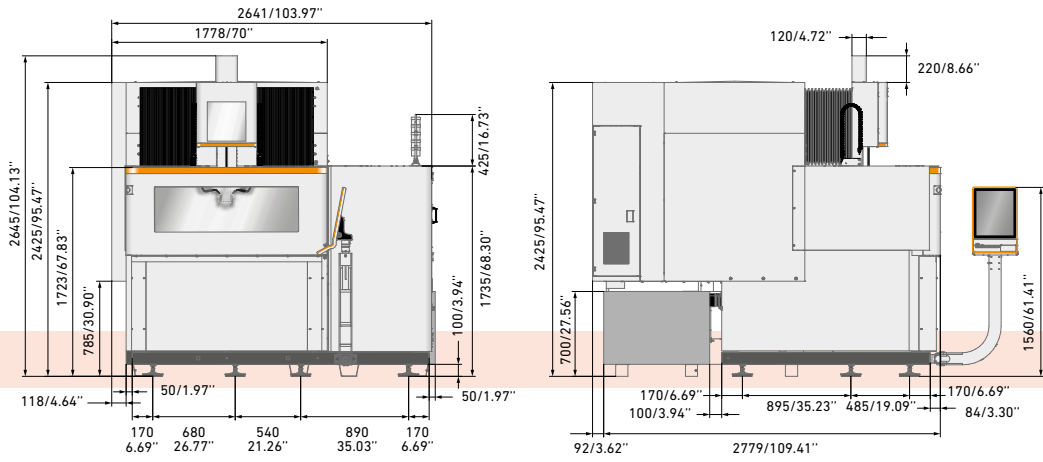

CUT P 1250

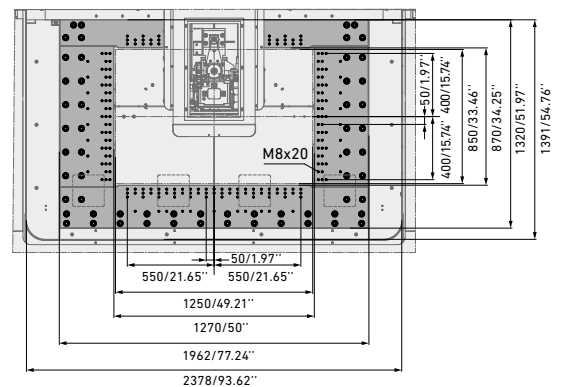
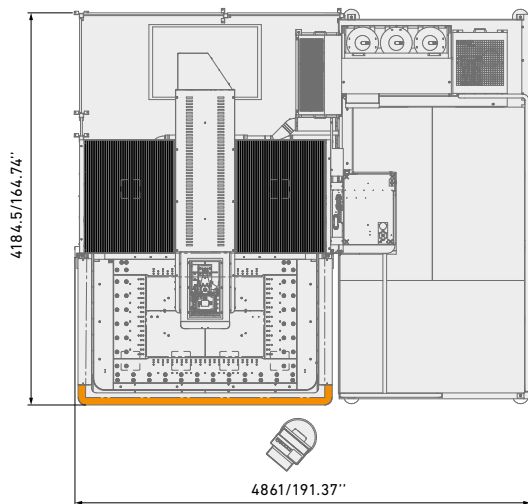
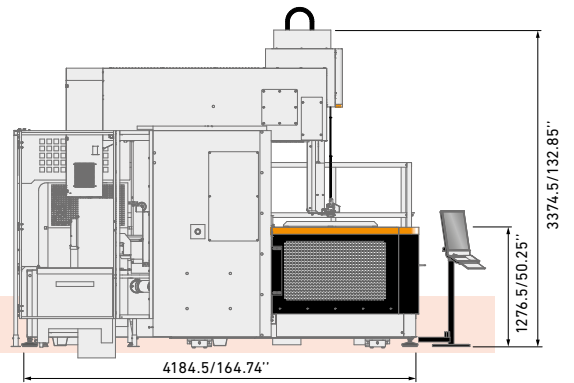
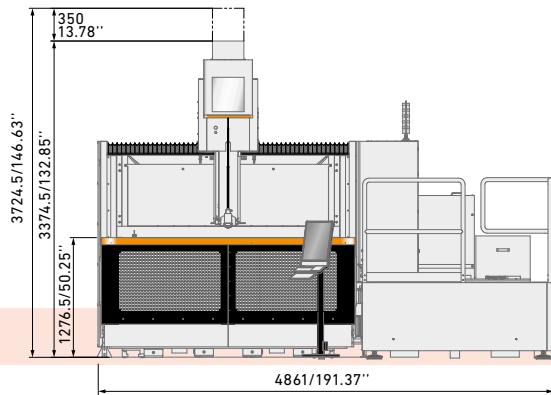

About GF Machining Solutions

Multi-technology solutions provider

Our commitment to you and your specific applications is proven by the value-adding intelligence, productivity and quality delivered by our multi-technology solutions. Your success is our chief motivator. That's why we are continuously advancing our legendary technical expertise. Wherever you are, whatever your market segment and whatever the size of your operation, we have the complete solutions and the customer-centric commitment to accelerate your success—today.

EDM (Electrical Discharge Machining)



Wire-cutting EDM

GF Machining Solutions' wire-cutting EDM is fast, precise and increasingly energy efficient. From ultraprecise machining of miniaturized components down to 0.02 mm to powerful solutions for demanding high-speed machining with respect to surface accuracy, our wire EDM solutions position you for success.

Die-sinking EDM

GF Machining Solutions is revolutionizing die-sinking EDM with features like iGAP technology to dramatically boost machining speed and reduce electrode wear. All of our die-sinking systems offer fast removal and deliver mirror finishes of Ra 0.1 µm (4 µin).

Hole-drilling EDM

GF Machining Solutions' robust hole-drilling EDM solutions enable you to drill holes in electrically conductive materials at a very high speed—and, with a five-axis configuration, at any angle on a workpiece with an inclined surface.

Tooling and Automation



Tooling

Our customers experience complete autonomy while maintaining extreme accuracy, thanks to our highly accurate System 3R reference systems for holding and positioning electrodes and work pieces. All types of machines can easily be linked, which reduces set-up times and enables a seamless transfer of workpieces between different operations.

Automation

Together with System 3R, we also provide scalable and cost-effective Automation solutions for simple, single machine cells or complex, multi-process cells, tailored to your needs.

Milling



Milling

Precision tool and mold manufacturers enjoy a competitive edge with our Mikron MILL S solutions' fast and precise machining. The Mikron MILL P machines achieve above-average productivity thanks to their high performance and Automation. Customers seeking fastest return on investment benefit from the affordable efficiency of our MILL E solutions.

High Performance Airfoil Machining

Our Liechti turnkey solutions enable the highly dynamic manufacturing of precision airfoils. Thanks to the unique performance and our expertise in airfoil machining, you increase productivity by producing at the lowest cost per part.

Spindles

As part of GF Machining Solutions, Step-Tec is engaged in the very first stage of each machining center development project. Compact design combined with excellent thermal and geometric repeatability ensure the perfect integration of this core component into the machine tool.

Software



Digitalization solutions

To drive its digital transformation, GF Machining Solutions acquired symmedia GmbH, a company specialized in software for machine connectivity. Together, we offer a complete range of Industry 4.0 solutions across all industries. The future requires the ability to adapt quickly to continual digital processes. Our intelligent manufacturing offers embedded expertise, optimized production processes, and workshop Automation: solutions for smart and connected machines.

Advanced manufacturing



Laser texturing

Aesthetic and functional texturing is easy and infinitely repeatable with our digitized Laser technology. Even complex 3D geometries, including precision parts, are textured, engraved, microstructured, marked and labeled.

Laser micromachining

GF Machining Solutions offers the industry's most complete line of Laser micromachining platforms optimized for small, high-precision features to meet the increasing need for smaller, smarter parts to support today's leading-edge products.

Laser Additive Manufacturing (AM)

GF Machining Solutions and 3D Systems, a leading global provider of additive manufacturing solutions and the pioneer of 3D printing, have partnered to introduce new metal 3D printing solutions that enable manufacturers to produce complex metal parts more efficiently.

Customer Services



Worldwide for you

Ensuring the best performance throughout the lifetime of our customers' equipment is the goal of our three levels of support. Operations Support offers the complete range of original wear parts and certified consumables. Machine Support includes spare parts, technical support, and a range of preventive services to maximize machine uptime. Business Support offers customer-specific business solutions.



Switzerland

Biel/Bienne
Losone
Geneva
Flawil
Langnau

www.gfms.com
www.gfms.com/ch

Europe

Germany, Schorndorf
www.gfms.com/de

United Kingdom, Coventry
www.gfms.com/uk

Italy, Agrate Brianza - MI
www.gfms.com/it

Spain, Sant Boi de Llobregat
Barcelona
www.gfms.com/es

France, Palaiseau
www.gfms.com/fr

Poland, Raszyn / Warsaw
www.gfms.com/pl

Czech Republic, Brno
www.gfms.com/cz

Sweden, Vällingby
www.gfms.com/system3r

Turkey, Istanbul
www.gfms.com/tr

Americas

USA
Lincolnshire, IL
Chicago, IL
Holliston, MA
Huntersville, NC
Irvine, CA
Woodridge, IL
www.gfms.com/us

Canada, Mississauga ON
www.gfms.com/us

Mexico, Monterrey NL
www.gfms.com/us

Brazil, São Paulo
www.gfms.com/br

Asia

China
Beijing, Shanghai,
Chengdu, Dongguan,
Hongkong, Changzhou
www.gfms.com/cn

India, Bangalore
www.gfms.com/sg

Japan
Tokyo, Yokohama
www.gfms.com/jp

Korea, Seoul
www.gfms.com/kr

Malaysia, Petaling Jaya
www.gfms.com/sg

Singapore, Singapore
www.gfms.com/sg

Taiwan
Taipei, Taichung
www.gfms.com/tw

Vietnam, Hanoi
www.gfms.com/sg

At a glance

We enable our customers to run their businesses efficiently and effectively by offering innovative Milling, EDM, Laser, Additive Manufacturing, Spindle, Tooling and Automation solutions. A comprehensive package of Customer Services completes our proposition.

www.gfms.com

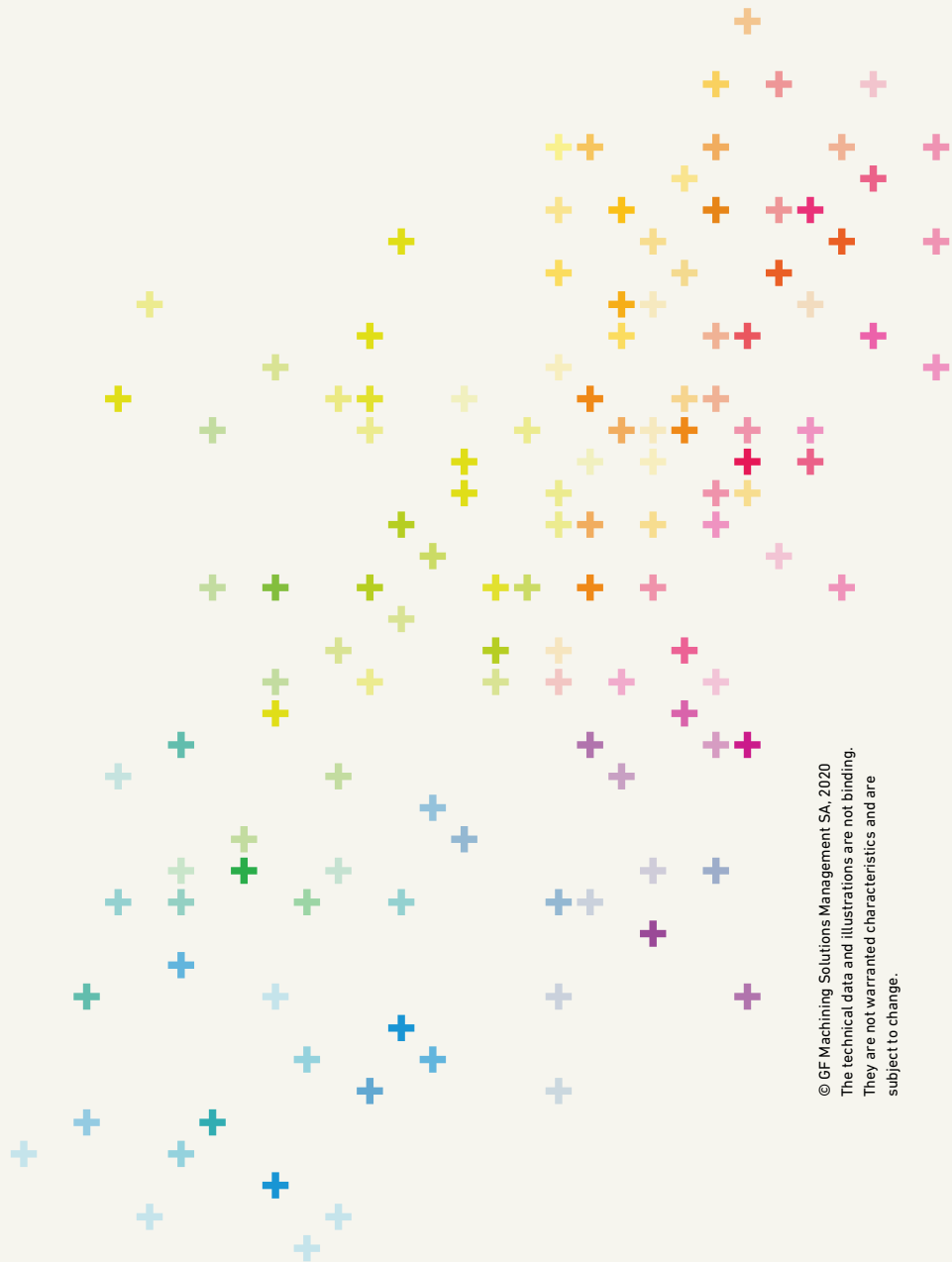

© GF Machining Solutions Management SA, 2020
The technical data and illustrations are not binding.
They are not warranted characteristics and are
subject to change.